

LINED PIPES AND PIPE FITTINGS



LINED PIPING SYSTEMS for Corrosive Applications



AUTHORISED DISTRIBUTOR FOR
Australia/NZ/PNG/Philippines

RHINOFLEX™

RHINOFLEX VALVE SOLUTIONS PTY.LTD

4/7 Holder Way, Malaga, W.A 6090

Phone: +61 -08 61130808

sales@rfvs.com.au



UNPPolyvalves

Manufacturer of PFA/FEP/PTFE Lined & Plastic Valves,
Pipes & Pipe Fittings

ABOUT US

UNP Polyvalves is manufacturing and supplying valve solutions for corrosive applications since 1988.

Considering Indian market not having a good valve manufacturing plants for corrosive application valves in 80's and huge project requirements coming up during these years UNP promoters decided to install a corrosive application valve manufacturing plant in Vadodara, Gujarat.

UNP with its possession of highly knowledgeable and skilled work force along with technically qualified and experienced promoters having vision to grow and guide their team to be the world leading brand, market leaders and make products which are high in performance and having unmatched quality and reliability, has excelled in all these requirements of market.

Taking up the challenge UNP started its first manufacturing plant just admeasuring 1600 square feet, it started with manufacturing of solid plastic valves in very few options in terms of material of construction, type of valves and size range.

UNP started working very closely with the chemical process industries in India, Understanding their difficulties and requirements UNP always worked towards solutions to the problems in industries and earned very good name not only in domestic market but also in international market.

UNP understanding the changing market trends and requirements, entered in the business of Lined Valves and Piping systems in the year 1992 and has now become a leading brand in providing most reliable Lined Valves and Piping system to the chemical process industries.

Envisioned for quality and reliability, UNP Polyvalves aims for highest level of customer satisfaction through its solutions with commitment for excellence in all spheres of business.

UNP today provides both Solid Plastic and Lined, Ball Valves, Plug Valves, Butterfly Valves, Diaphragm Valves, Ball Check Valves, Swing Check Valves, Sampling Valves, Double Window and Full View Sight Glasses, Y and T type strainers, Lined Pipes and Fittings with sizes ranging from ½" to 24".

UNP has marked its presence across the globe and are having establishments in countries like North America and exporting to 35+ countries through its distribution networks and to the direct end users.

ACHIEVEMENTS

UNP through its knowledge about the exact process conditions and technical expertise has helped chemical industries in resolving their corrosion problems and operational problems related to Plastic valves, Lined Valves and Piping systems. Chlor Alkali Plants, Pickling Lines and Acid regeneration plants in steel industries, Chemical injection skid manufacturers in Oil and Gas industries and many other plants having corrosion problems have been benefited by our knowledge and expertise.

UNP is approved brand by leading consulting and EPC companies such as UHDE, JACOBS Engineering, Mott Mcdonalds, Toyo Engineering, Fluor Daniel, EIL etc and have worked for their very prestigious project over these years.

LINING DATA

LINER PROPERTIES		UNIT	PTFE	PFA
Operating Temperature	°C	-29 To 260	-29 To 260	-29 To 260
Specific Gravity	g/cm ³	2.14 - 2.19	2.12 - 2.17	2.12 - 2.17
Liner Color	NA	white	natural	natural
Tensile Strength of Liner at Yield (minimum)	psi	3000	3800	3800
Elongation of Liner at Yield (minimum)	%	250	300	300
Melt Point	°C	330	330	330

Lined Pipe Dimensions

UNP Polyvalves manufactures PTFE lined pipe in 1" to 24" sizes in various grades of metal systems, from carbon steel to stainless steel. These systems are available in ANSI class 150, class 300 and DIN flange dimensions. The lined pipe can be easily field fabricated. Options such as vent hole extensions and special paint are available.

NB (INCH)	STEEL PIPE DIMENSIONS OD		LINER THICKNESS PTFE	
	INCH	MM	INCH	MM
1"	1.315	33.4	0.125	3.2
1½"	1.900	48.3	0.125	3.2
2"	2.375	60.3	0.137	3.5
3"	3.500	88.9	0.165	4.2
4"	4.500	114.3	0.177	4.5
6"	6.625	168.3	0.216	5.5
8"	8.625	219.1	0.216	5.5
10"	10.750	273.1	0.255	6.5
12"	12.750	323.9	0.255	6.5
14"	14.000	355.6	0.255	6.5
16"	16.000	406.4	0.255	6.5
18"	18.000	457.2	0.255	6.5
20"	20.000	508.0	0.255	6.5

Notes

1. Liners and fittings meet the following Specifications:

- 1" - 8" liners and fittings are fully rated for vacuum at 200°C.
 - 10" - 12" liners are vacuum rated at 200°C with restriction on length of pipe spools.
 - 14" - 20" lined pipe & fittings, customers will have to make special request for vacuum rated lining.
2. Standard 1" - 8" fittings meet or exceed pipe liner thickness and vacuum ratings for same-sized liner.

MANUFACTURING STANDARDS

All lined pipe and fitting fully comply with the ASTM F1545 standard. Products are manufactured to the following specifications and requirements

LINER POLYMERS	STANDARDS
PTFE (polytetrafluoroethylene)	ASTM D4894, D4895
PFA (perfluoroalkoxy)	ASTM D3307
PVDF (polyvinylidene fluoride)	ASTM D3222
PPH (polypropylene homopolymer)	ASTM D4101
ETFE (ethylene tetrafluoroethylene)	ASTM D3159
FEP (fluorinated ethylene propylene)	ASTM D2116

PIPE NB (INCH)	MATERIAL	STANDARDS
1" - 6"	Schedule 40	ASTM A106, Grade B
8" - 24"	Schedule 20	ASTM A106, Grade B

FLANGES TYPE	SIZE (INCH)	MATERIAL	STANDARDS
Lap Joint	1" - 24"	ASTM A105	ANSI B16.5 150#, DIN or JIS
SOFF	1" - 24"	IS 2062	ANSI B16.5 150#, DIN or JIS
SOFF	1" - 24"	ASTM A182 F304	ANSI B16.5 150#, DIN or JIS
SOFF	1" - 24"	ASTM A182 F316	ANSI B16.5 150#, DIN or JIS

FITTINGS TYPE	STANDARDS
Fabricated	ASTM A106, GRADE B & A234 as per manufacturer's drawing; dimensions ANSI B16.5 class 150
Casting	ASTM A216, Grade WCB; dimensions ANSI B16.5 class 150
Flange	One side fix other side rotating

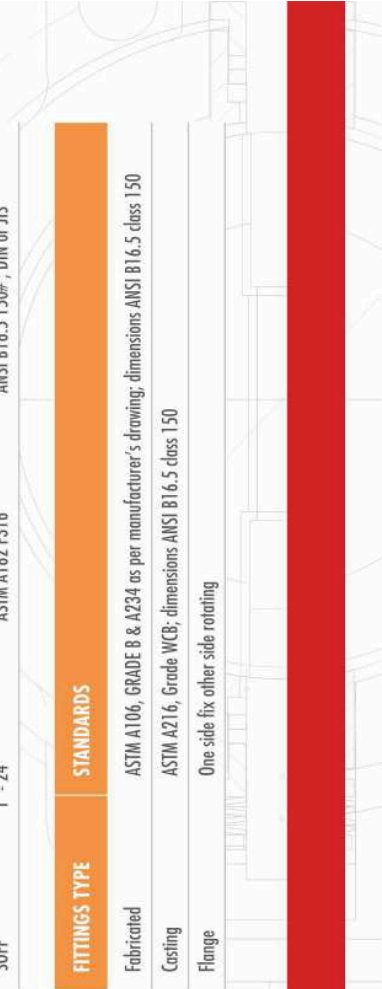

FABRICATION TOLERANCES FOR PIPE AND FITTINGS

DIMENSIONS	TOLERANCE (INCH)
Length and centreline	± 1/8
Fixed flange bolt hole alignment	± 1/16
Perpendicular of flange with centreline of pipe	3/32 per foot of pipe diameter

Venting

PTFE Lined pipe spools 500mm or less have 1 venthole of 3mm diameter in the centre of the pipe spool. Pipe spools having length more than 500mm have 2 vent holes of the 3mm diameter one near flange.

External Protective Coating and Marking

Metal surface of pipe and fitting are given a protective coating of primer prior to leaving the manufacturing facility to protect the metal surface from rust. We also provide specialized primers & paints if required by the customer.

Processes

Our performance piping systems are manufactured using innovative fluoropolymer processing technology, ensuring products are of the highest quality and will provide long term performance. Pipe liners are manufactured using the paste extrusion process to increase permeation resistance, produce a smooth interior surface & provide improved structural stability. Process of injection molding is used in manufacturing of the fittings.

QUALITY ASSURANCE INSPECTION AND HANDLING

The performance and longevity of PTFE lined pipe system components depends on the quality control of design and fabrication processes, as well as shipping, handling and strong practice. Quality control teams inspect and test all PTFE & PFA lined pipe components to ensure they meet or exceed ASTM F1545 specifications.

Inspections performed prior to lining

- All metal pipe and fittings are visually inspected before lining. The interior will be smooth, clean and free of burrs, scale or any other deposits. Internal welds are ground smooth.
- Pipe liners are examined for pinholes, cracks, gouges, nicks or foreign objects.

Tests and Inspections Performed After Lining

- Pipe spools & Fittings are hydrotested at 29.6 kg/cm² (3min). All components are subject to an electrostatic spark test at 10kva
- The Liner forming the flange gasket sealing face is visually inspected for smoothness. The liner will be free of defects (pinholes, cracks, gouges, nicks or foreign objects).
- Lined pipe and fittings are checked for dimensional accuracy and tolerances in accordance with dimensional data listed within this catalog and ANSI specifications.
- After final inspection, a flange protector is installed on each flange prior to any further handling of the part.

Shipping, Handling and Storage

- Prior to shipment, all sealing surfaces of lined products are covered by a flange protector. Removal of the flange protector should occur only at installation. For cases in which testing is required before installation, flange protectors need to be reinstalled immediately after testing.
- Slings, chains or lifting equipment should not be placed inside lined products or otherwise come in contact with the plastic liner. Extreme care must be taken at all time when loading, transporting and unloading products to and form a truck or trailer. Use chains and slings to lift the spools rather than drag them.
- Avoid storage in direct sunlight or other severe conditions. Storage under cover is recommended.
- Protection of the flare faces is necessary during handling, sandblasting and painting. Do not plug vent holes.
- Failure to follow shipping, handling and storage instructions will void the product warranty.

INSTALLATION INSTRUCTIONS

Do not remove flange protectors prior to installations to prevent damage to the sealing surface. Flange protectors should be replaced any time the item is removed from service.

Recommended Bolt Torque

Recommended torque rating are based on lightly lubricated A193 B7 bolts and A194 2H nuts. When bolting dissimilar liner materials, use the lower torque value.

ANSI class 150 system Lightly lubricated A 193 B7 bolts and A194 2H nuts. Use the lower torque value when bolting dissimilar liner materials.									
Size (inch)	1"	1½"	2"	3"	4"	6"	8"	10"	12"
PTFE	14	21	34	41	55	82	95	102	129
Maximum Bolt Torque	in lb	120	180	300	360	480	720	840	1140

Bolt Torque Sequence

Finger-tighten all nuts and bolts. With a calibrated torque wrench, tighten each flange connection in a crisscross pattern (refer to figure). Using this pattern, tighten in 20% increments up to 80% of the final bolt torque. To achieve the final torque value, tighten bolts in a sequential clockwise pattern once around the flange. Maximum recommended torque is suggested for systems that will be operating at or near the maximum pressure and temperature limits of the liner or conveying small molecular gasses.

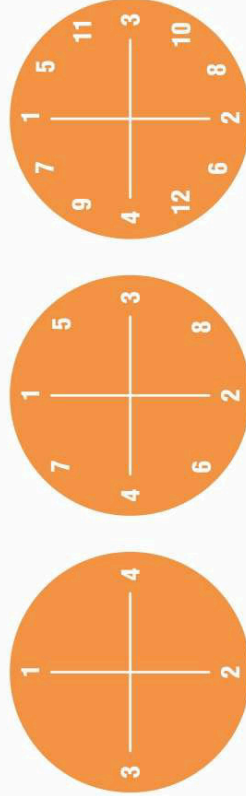

Retorquing

- After the initial installation, we recommend checking the torque of each bolt after 24 hours have elapsed or a temperature cycle or pressure cycle (hydrostatic test) has occurred. Any bolts falling below the recommended value should be retorqued. Values should only be exceeded by 10% increments when necessary to reseal. All torquing on the process system should be done when the system is ambient and cool.
- Retorquing should be performed annually, especially if the system experience elevated temperature or extreme temperature swings.

Other Installation Guidelines

- Welding should not be performed before or after the installation of lined pipe components.
- Gaskets must be used when bolting components to dissimilar products made from metal, glass, fiberglass or other materials. Otherwise, gaskets are not required for bolting together lined piping systems unless repeated connections and disconnections are made.
- Vent holes should not be plugged. Do not use sharp tools to clean plugged holes.
- Do not remove pipe spools and fittings from systems at elevated temperatures. Always install a flange protector immediately after the component is removed.

NB (INCH)	BOLT LENGTH (INCH)		STUD LENGTH (INCH)	
	FIXED	ROTATING	FIXED	ROTATING
1"	2 ½"	2 ¾"	3"	3 ¼"
1½"	2 ¾"	3"	3 ¼"	3 ½"
2"	3 ¼"	3 ½"	4"	4 ¼"
3"	3 ½"	4"	4 ¼"	4 ½"
4"	3 ½"	4"	4 ¼"	4 ½"
6"	4 ¼"	4 ½"	5"	5 ¼"
8"	4 ¼"	4 ¾"	5"	5 ½"
10"	4 ½"	5 ¼"	5 ½"	6"
12"	4 ¾"	5 ½"	5 ½"	6 ¼"

PIPES

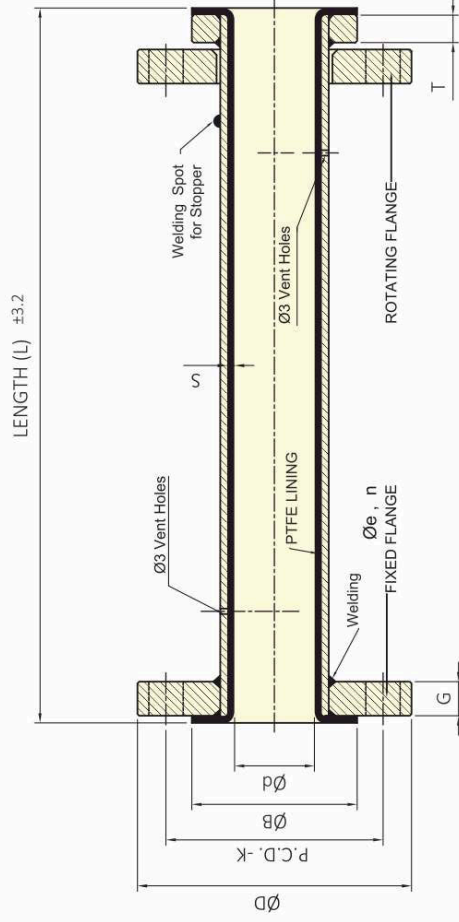

NOTE : PIPE LENGTH LESS THAN OR EQUAL TO 500mm ONE VENT HOLE IN CENTER

Material Specifications

1. Pipe : Seamless Carbon Steel Pipe
As per ASTM A 106 GR.B, SCH 40 (upto 6")
As per ASTM A 106 GR.B, SCH 20 (above 6")
2. Flange : A105 - 150#
3. Lining : PTFE conforming ASTM D4895

Dimension Specifications

1. All dimensions are in mm.
2. Pipe as per ANSI B36.10
3. Flange as per ANSI B16.5, 150#
4. Tolerances on length of the piping will be ± 3.2 mm.
5. Lining and other dimensional tolerances as per ASTM F1545
6. Lining face thickness 80% of min. liner wall Thk.

Testing

1. 100% Visual Check
2. 100% Dimensional Check
3. 100% Spark Test At 15 KVDC.
4. 100% Hydro Test At 29 kg/cm² holding time 3 min., as per ASTM F1545 (after Lining)

DIMENSION TABLE

Size	L - ID (∅d)		∅R/F (∅B)		F. OD (∅D)		F. THK (G)		STUB END (T)		P.C.D. (K)		H - DIA (∅e)		NH(h)		LINING THK (S)		C.S. PIPE (SCH)
	INCH	MM	INCH	MM	INCH	MM	INCH	MM	INCH	MM	INCH	MM	INCH	MM	INCH	MM	INCH	MM	
1/2"	0.39	10	1.37	34.9	3.50	88.9	0.44	11.1	0.35	8.9	2.37	60.3	0.63	15.9	04	0.126	3.2	40	
3/4"	0.59	15	1.68	42.7	3.87	98.4	0.50	12.7	0.40	10.2	2.75	69.8	0.63	15.9	04	0.126	3.2	40	
1"	0.79	20	2.01	51	4.25	108	0.56	14.2	0.45	11.4	3.13	79.4	0.63	15.9	04	0.126	3.2	40	
1.5"	1.34	34	2.87	73	5.00	127	0.69	17.5	0.55	14	3.87	98.4	0.63	15.9	04	0.126	3.2	40	
2"	1.73	44	3.62	92	6.00	152.4	0.75	19	0.60	15.2	4.75	120.6	0.75	19	04	0.138	3.5	40	
3"	2.76	70	5.00	127	7.50	190.5	0.94	23.8	0.75	19.0	6.00	152.4	0.75	19	04	0.157	4	40	
4"	3.70	94	6.18	157	9.00	228.6	0.94	23.8	0.75	19.0	7.50	190.5	0.75	19	08	0.177	4.5	40	
6"	5.67	144	8.50	216	11.00	279.4	1.00	25.4	0.80	20.3	9.50	241.3	0.87	22.2	08	0.217	5.5	40	
8"	7.64	194	10.63	270	13.50	342.9	1.13	28.6	0.90	22.9	11.75	298.4	0.87	22.2	08	0.217	5.5	20	
10"	9.72	247	12.76	324	16.00	406.4	1.19	30.2	0.95	24.2	14.25	362	1.00	25.4	12	0.256	6.5	20	
12"	11.73	298	15.00	381	19.00	482.6	1.25	31.8	1.00	25.4	17.00	431.8	1.00	25.4	12	0.256	6.5	20	
14"	12.83	326	16.26	413	21.00	533.4	1.37	34.9	1.10	27.9	18.75	476.3	1.13	28.6	12	0.256	6.5	20	
16"	14.84	377	18.50	470	23.50	596.9	1.44	36.5	1.15	29.2	21.25	539.8	1.13	28.6	16	0.256	6.5	20	
18"	16.85	428	21.00	533.4	25.00	635	1.56	39.7	1.25	31.8	22.75	577.9	1.25	31.8	16	0.256	6.5	20	
20"	18.70	475	23.00	584.2	27.50	698.5	1.69	42.9	1.35	34.3	25.00	635	1.26	32	20	0.256	6.5	20	

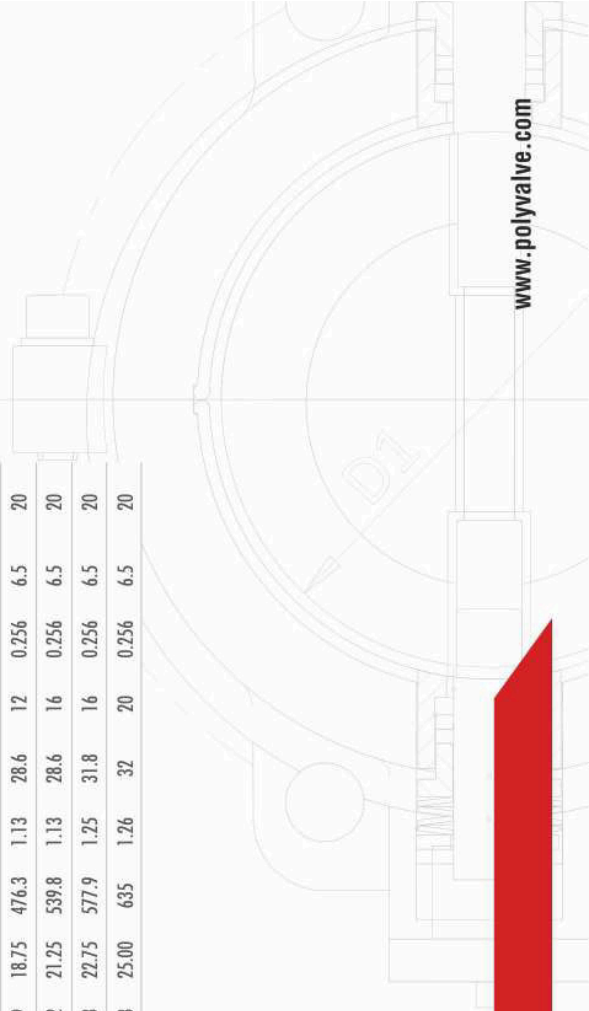



ELBOWS 90°

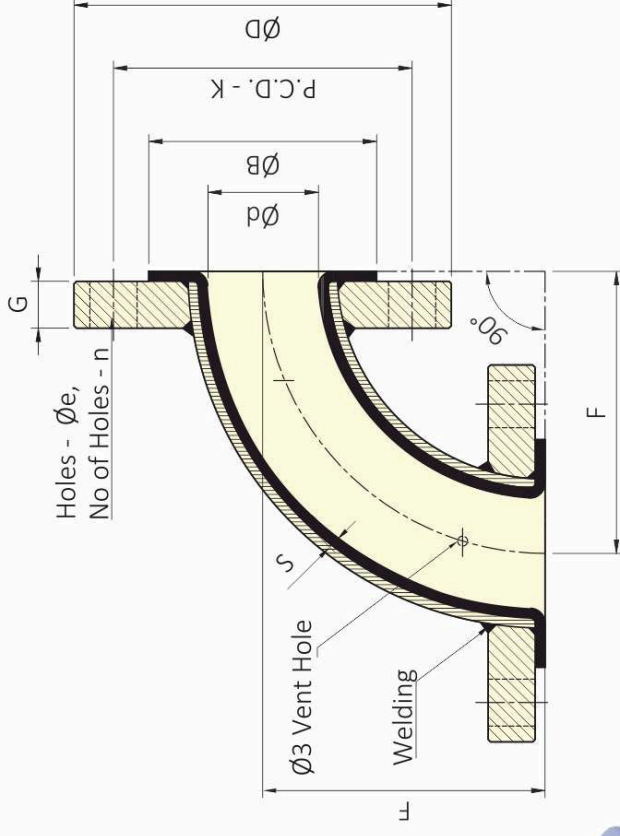

Material Specifications

- 90° Bend : ASTM A 234 GR. WPB, SCH 40 (upto 6")
ASTM A 234 GR. WPB, SCH 20 (above 6")
- Flange : ASTM A 105 - As per ASME B 16.5, 150#
- Liner : PTFE conforming ASTM D 4895

Dimension Specifications

- All dimensions are in mm.
- Bend as per ANSI B36.10
- Flange as per ANSI B16.5, 150#
- Lining and other dimensional tolerances as per
ASTM F1545
- Lining face thickness 80% of min. liner wall Thk.

Testing

- 100% Visual Check
- 100% Dimensional Check
- 100% Spark Test At 15 KVDC.
- 100% Hydro Test At 29 kg/cm² holding time 3 min.,
as per ASTM F1545
(after Lining)

DIMENSION TABLE

Size	L - ID (∅d)		∅R/F (∅B)		F. OD (∅D)		E. THK (G)		P.C.D. (K)		H - DIA (∅e)		NH (n)		LINING THK (S)		F		WPB ELBOW (SCH)
	INCH	MM	INCH	MM	INCH	MM	INCH	MM	INCH	MM	INCH	MM	INCH	MM	INCH	MM	INCH	MM	
1/2"	0.39	10	1.37	34.9	3.50	88.9	0.44	11.1	2.37	60.3	0.63	15.9	04	0.126	3.2	2.56	65	40	
3/4"	0.59	15	1.68	42.7	3.87	98.4	0.50	12.7	2.75	69.8	0.63	15.9	04	0.126	3.2	2.95	75	40	
1"	0.79	20	2.01	51	4.25	108	0.56	14.2	3.13	79.4	0.63	15.9	04	0.126	3.2	3.50	89	40	
1.5"	1.34	34	2.87	73	5.00	127	0.69	17.5	3.87	98.4	0.63	15.9	04	0.126	3.2	4.02	102	40	
2"	1.73	44	3.62	92	6.00	152.4	0.75	19	4.75	120.6	0.75	19	04	0.138	3.5	4.49	114	40	
3"	2.76	70	5.00	127	7.50	190.5	0.94	23.8	6.00	152.4	0.75	19	04	0.157	4	5.51	140	40	
4"	3.70	94	6.18	157	9.00	228.6	0.94	23.8	7.50	190.5	0.75	19	08	0.177	4.5	6.50	165	40	
6"	5.67	144	8.50	216	11.00	279.4	1.00	25.4	9.50	241.3	0.87	22.2	08	0.217	5.5	7.99	203	40	
8"	7.64	194	10.63	270	13.50	342.9	1.13	28.6	11.75	298.4	0.87	22.2	08	0.217	5.5	9.02	229	20	
10"	9.72	247	12.76	324	16.00	406.4	1.19	30.2	14.25	362	1.00	25.4	12	0.256	6.5	10.98	279	20	
12"	11.73	298	15.00	381	19.00	482.6	1.25	31.8	17.00	431.8	1.00	25.4	12	0.256	6.5	12.01	305	20	
14"	12.83	326	16.26	413	21.00	533.4	1.37	34.9	18.75	476.3	1.13	28.6	12	0.256	6.5	14.02	356	20	
16"	14.84	377	18.50	470	23.50	596.9	1.44	36.5	21.25	539.8	1.13	28.6	16	0.256	6.5	15.00	381	20	
18"	16.85	428	21.00	533.4	25.00	635	1.56	39.7	22.75	577.9	1.25	31.8	16	0.256	6.5	16.50	419	20	
20"	18.70	475	23.00	584.2	27.50	698.5	1.69	42.9	25.00	635	1.26	32	20	0.256	6.5	17.99	457	20	

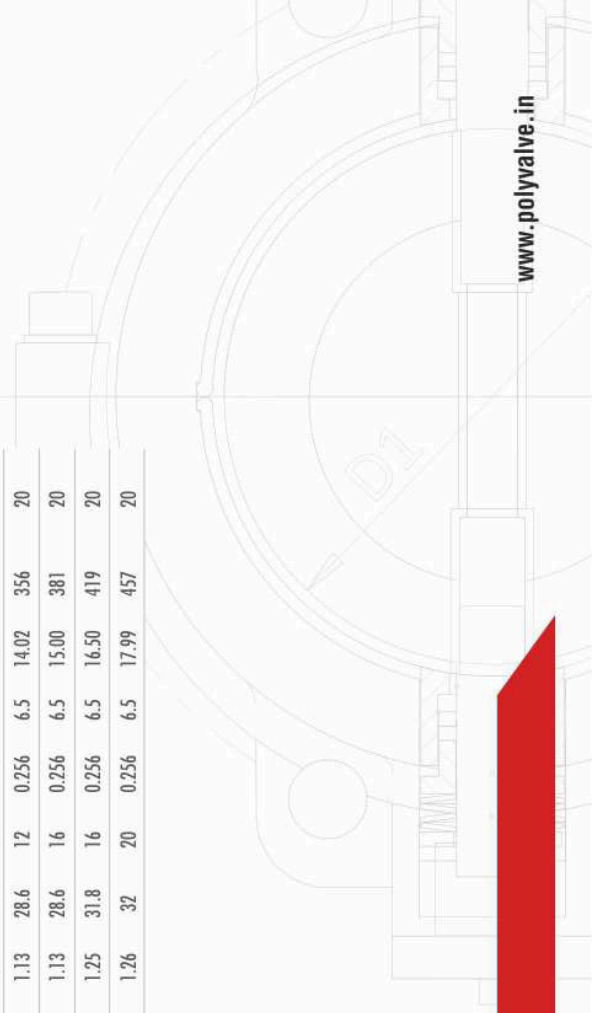

ELBOWS 45°

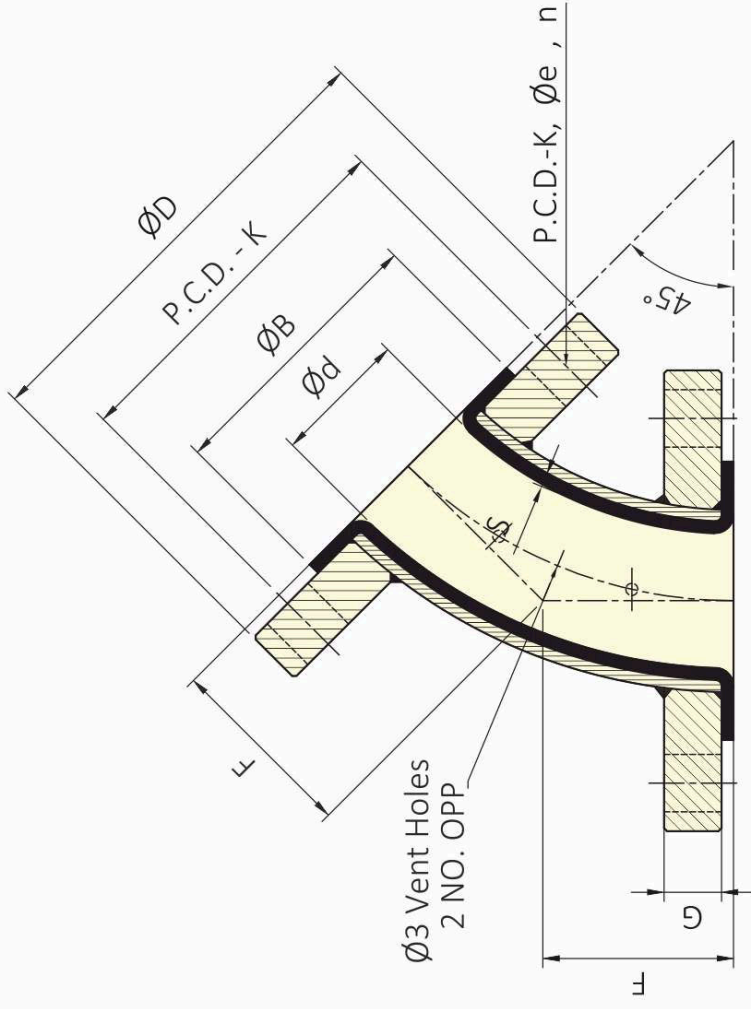

Material Specifications

- 45° Bend : ASTM A 234 GR. WPB, SCH 40 (upto 6")
ASTM A 234 GR. WPB, SCH 20 (above 6")
- Flange : A105 - As per ASME B 16.5, 150#
- Liner : PTFE conforming ASTM D 4895

Dimension Specifications

- All dimensions are in mm.
- Bend as per ANSI B36.10
- Flange as per ANSI B16.5, 150#
- Lining and other dimensional tolerances as per ASTM F1545
- Lining face thickness 80% of min. liner wall Thk.

Testing

- 100% Visual Check
- 100% Dimensional Check
- 100% Spark Test At 15 KVDC.
- 100% Hydro Test At 29 kg/cm² holding time 3 min., as per ASTM F1545 (after Lining)

DIMENSION TABLE

Size	L - ID (∅d)		∅R/F (∅B)		F. OD (∅D)		E. THK (G)		P.C.D. (K)		H - DIA (∅e)		NH (n)		LINING THK (S)		F		WPS ELBOW (SCH)
	INCH	MM	INCH	MM	INCH	MM	INCH	MM	INCH	MM	INCH	MM	INCH	MM	INCH	MM	INCH	MM	
	0.079	+2	0.079	+2					0.06	+1.6							0.059	+1.5	
1/2"	0.39	10	1.37	34.9	3.50	88.9	0.44	11.1	2.37	60.3	0.63	15.9	04	0.126	3.2	1.73	44	40	
3/4"	0.59	15	1.68	42.7	3.87	98.4	0.50	12.7	2.75	69.8	0.63	15.9	04	0.126	3.2	1.73	44	40	
1"	0.79	20	2.01	51	4.25	108	0.56	14.2	3.13	79.4	0.63	15.9	04	0.126	3.2	1.73	44	40	
1.5"	1.34	34	2.87	73	5.00	127	0.69	17.5	3.87	98.4	0.63	15.9	04	0.126	3.2	2.24	57	40	
2"	1.73	44	3.62	92	6.00	152.4	0.75	19	4.75	120.6	0.75	19	04	0.138	3.5	2.52	64	40	
3"	2.76	70	5.00	127	7.50	190.5	0.94	23.8	6.00	152.4	0.75	19	04	0.157	4	2.99	76	40	
4"	3.70	94	6.18	157	9.00	228.6	0.94	23.8	7.50	190.5	0.75	19	08	0.177	4.5	4.02	102	40	
6"	5.67	144	8.50	216	11.00	279.4	1.00	25.4	9.50	241.3	0.87	22.2	08	0.217	5.5	5.00	127	40	
8"	7.64	194	10.63	270	13.50	342.9	1.13	28.6	11.75	298.4	0.87	22.2	08	0.217	5.5	5.51	140	20	
10"	9.72	247	12.76	324	16.00	406.4	1.19	30.2	14.25	362	1.00	25.4	12	0.256	6.5	6.50	165	20	
12"	11.73	298	15.00	381	19.00	482.6	1.25	31.8	17.00	431.8	1.00	25.4	12	0.256	6.5	7.48	190	20	
14"	12.83	326	16.26	413	21.00	533.4	1.37	34.9	18.75	476.3	1.13	28.6	12	0.256	6.5	7.48	190	20	
16"	14.84	377	18.50	469.9	23.50	596.9	1.44	36.5	21.25	539.8	1.13	28.6	16	0.256	6.5	7.99	203	20	
18"	16.85	428	21.00	533.4	25.00	635	1.56	39.7	22.75	577.9	1.25	31.8	16	0.256	6.5	8.50	216	20	
20"	18.70	475	23.00	584.2	27.50	698.5	1.69	42.9	25.00	635	1.26	32	20	0.256	6.5	9.49	241	20	

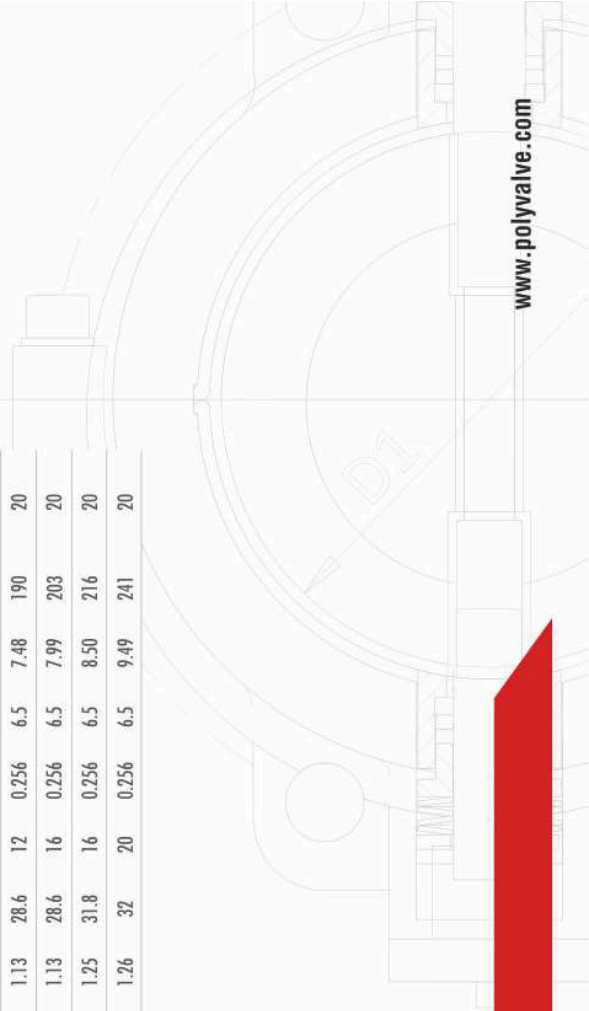

EQUAL TEES

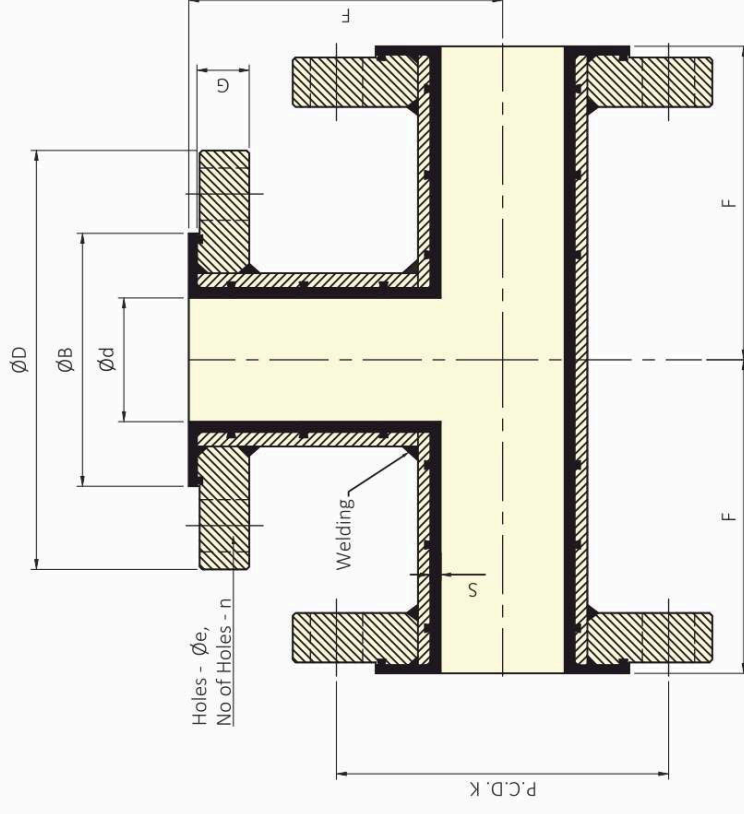

Material Specifications

1. EQ. TEE : Made From Fabricated Seamless Carbon Steel Pipe:
As per ASTM A 106 GR.B, SCH 40 (upto 6")
As per ASTM A 106 GR.B, SCH 20 (above 6")
2. Flange : ASTM A 105 as per ANSI B 16.5, 150#
3. Liner : PFA conforming ASTM D 3307

Dimension Specifications

1. All dimensions are in mm.
2. Pipe as per ANSI B36.10
3. Flange as per ANSI B16.5, 150#
4. Lining and other dimensional tolerances as per ASTM F1545

Testing

1. 100% Visual Check
2. 100% Dimensional Check
3. 100% Spark Test At 15 KVDC.
4. 100% Hydro Test At 29 kg/cm² holding time 3 min., as per ASTM F1545 (after Lining)

DIMENSION TABLE

Size	L - ID (∅d)		∅R/F (∅B)		F. OD (∅D)		F. THK (G)		P.C.D. (K)		H - DIA (∅e)		NH (m)		LINING THK (S)		F		C.S. PIPE (SCH)
	MM	INCH	MM	INCH	MM	INCH	MM	INCH	MM	INCH	MM	INCH	MM	INCH	MM	INCH	MM	INCH	
1/2"	0.79	±2	1.37	0.079	±2	3.50	88.9	0.44	11.1	2.37	60.3	0.63	15.9	04	0.126	3.2	2.56	65	40
3/4"	0.59	15	1.68	42.7	3.87	98.4	0.50	12.7	2.75	69.8	0.63	15.9	04	0.126	3.2	2.95	75	40	
1"	0.79	20	2.01	51	4.25	108	0.56	14.2	3.13	79.4	0.63	15.9	04	0.138	3.5	3.50	89	40	
1.5"	1.34	34	2.87	73	5.00	127	0.69	17.5	3.87	98.4	0.63	15.9	04	0.138	3.5	4.02	102	40	
2"	1.73	44	3.62	92	6.00	152.4	0.75	19	4.75	120.6	0.75	19	04	0.157	4	4.49	114	40	
3"	2.76	70	5.00	127	7.50	190.5	0.94	23.8	6.00	152.4	0.75	19	04	0.177	4.5	5.51	140	40	
4"	3.70	94	6.18	157	9.00	228.6	0.94	23.8	7.50	190.5	0.75	19	08	0.177	4.5	6.50	165	40	
6"	5.67	144	8.50	216	11.00	279.4	1.00	25.4	9.50	241.3	0.87	22.2	08	0.177	4.5	7.99	203	40	
8"	7.64	194	10.63	270	13.50	342.9	1.13	28.6	11.75	298.4	0.87	22.2	08	0.177	4.5	9.02	229	20	
10"	9.53	242	12.76	324	16.00	406.4	1.19	30.2	14.25	362	1.00	25.4	12	0.217	5.5	10.98	279	20	
12"	11.46	291	15.00	381	19.00	482.6	1.25	31.8	17.00	431.8	1.00	25.4	12	0.217	5.5	12.01	305	20	
14"	12.64	321	16.26	413	21.00	533.4	1.37	34.9	18.75	476.3	1.13	28.6	12	0.256	6.5	14.02	356	20	
16"	14.49	368	18.50	470	23.50	596.9	1.44	36.5	21.25	539.8	1.13	28.6	16	0.256	6.5	15.00	381	20	
18"	16.34	415	21.00	533.4	25.00	635	1.56	39.7	22.75	577.9	1.25	31.8	16	0.256	6.5	16.50	419	20	
20"	18.31	465	23.00	584.2	27.50	698.5	1.69	42.9	25.00	635	1.26	32	20	0.256	6.5	17.99	457	20	

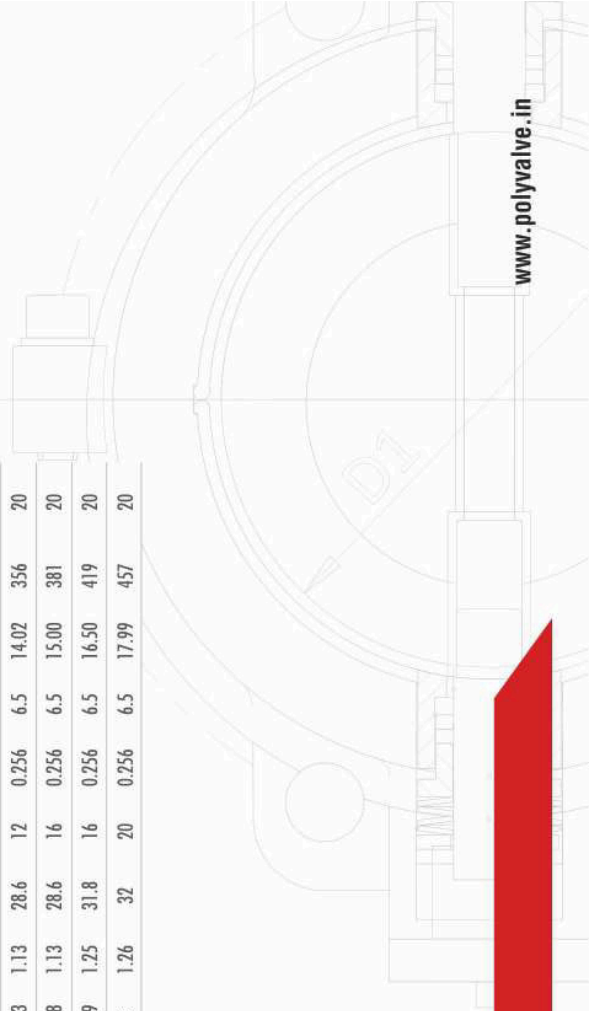

INSTRUMENT TEE

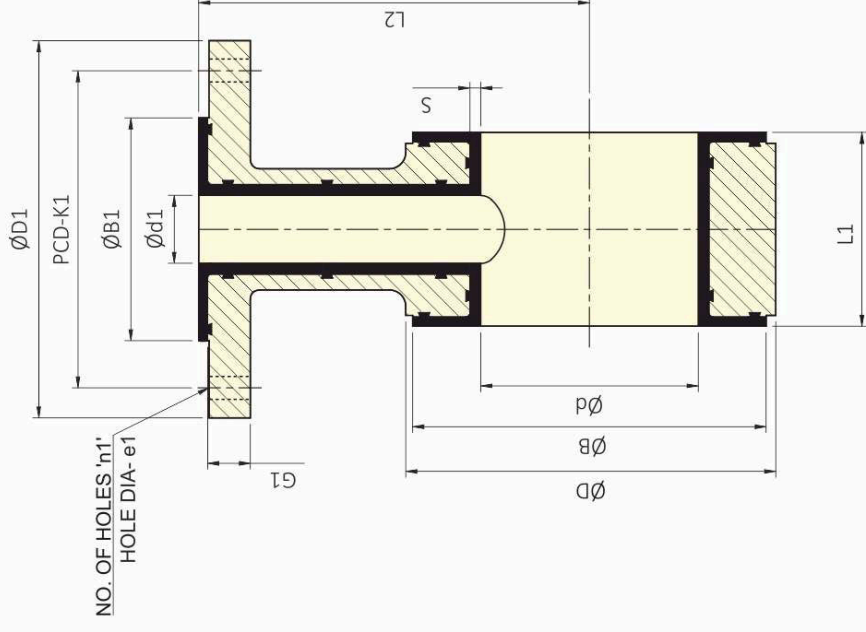

Material Specifications

1. Body MOC: ASTM A 216 Gr. WCB
2. Flange: As Per ANSI B 16.5, 150#
3. Lining: PFA conforming ASTM D 3307

Dimension Specifications

1. All dimensions are in mm.
2. Flange as per ANSI B16.5, 150#
3. Lining and other dimensional tolerances as per ASTM F1545

Testing

1. 100% Visual Check
2. 100% Dimensional Check
3. 100% Spark Test At 15 KVDC.
4. 100% Hydro Test At 29 kg/cm² holding time 3 min., as per ASTM F1545 (after Lining)

DIMENSION TABLE

Size	L - ID (∅d)		∅R/F (∅B)		∅D		Size	L - ID (∅d1)		∅R/F (∅B1)		E. OD (∅D1)		E. THK (G1)		P.C.D. (K1)		H - DIA (∅e1)		NH (n1)		LINING THK (S)		F TO F (L1)		F TO F (L2)	
	INCH	MM	INCH	MM	INCH	MM		INCH	MM	INCH	MM	INCH	MM	INCH	MM	INCH	MM	INCH	MM	INCH	MM	INCH	MM	INCH	MM	INCH	MM
	0,079	±2	0,079	±2	0,079	±2		0,079	±2	0,079	±2	0,079	±2	0,06	±1,6	0,06	±1,6	0,059	±1,5	0,059	±1,5	0,059	±1,5	0,059	±1,5	0,059	±1,5
1"	0.98	25	2.00	50.8	2.36	60	1"	0.79	20	2.01	51	4.25	108	0.56	14.2	3.13	79.4	0.63	16	04	0.138	3.5	1.97	50	3.50	89	
1.5"	1.57	40	2.87	73	3.15	80	1"	0.79	20	2.01	51	4.25	108	0.56	14.2	3.13	79.4	0.63	16	04	0.138	3.5	1.97	50	4.02	102	
2"	1.97	50	3.62	92	3.86	98	1"	0.79	20	2.01	51	4.25	108	0.56	14.2	3.13	79.4	0.63	16	04	0.138	3.5	1.97	50	4.49	114	
2"	1.97	50	3.62	92	3.86	98	1.5"	1.34	34	2.87	73	5.00	127	0.69	17.5	3.87	98.4	0.63	16	04	0.138	3.5	2.95	75	4.49	114	
3"	3.15	80	5.00	127	5.28	134	1"	0.79	20	2.01	51	4.25	108	0.56	14.2	3.13	79.4	0.63	16	04	0.138	3.5	1.97	50	5.31	135	
3"	3.15	80	5.00	127	5.28	134	1.5"	1.34	34	2.87	73	5.00	127	0.69	17.5	3.87	98.4	0.63	16	04	0.138	3.5	2.95	75	5.31	135	
3"	3.15	80	5.00	127	5.28	134	2"	1.73	44	3.62	92	6.00	152.4	0.75	19	4.75	120.6	0.75	19	04	0.157	4	3.54	90	5.31	135	
4"	3.94	100	6.18	157	6.46	164	1"	0.79	20	2.01	51	4.25	108	0.56	14.2	3.13	79.4	0.63	16	04	0.138	3.5	1.97	50	6.50	165	
4"	3.94	100	6.18	157	6.46	164	1.5"	1.34	34	2.87	73	5.00	127	0.69	17.5	3.87	98.4	0.63	16	04	0.138	3.5	2.95	75	6.50	165	
6"	5.91	150	8.18	208	8.50	216	1"	0.79	20	2.01	51	4.25	108	0.56	14.2	3.13	79.4	0.63	16	04	0.138	3.5	1.97	50	7.99	203	
6"	5.91	150	8.18	208	8.50	216	1.5"	1.34	34	2.87	73	5.00	127	0.69	17.5	3.87	98.4	0.63	16	04	0.138	3.5	1.97	75	7.99	203	
6"	5.91	150	8.18	208	8.50	216	2"	1.73	44	3.62	92	6.00	152.4	0.75	19	4.75	120.6	0.75	19	04	0.157	4	1.97	90	7.99	203	
8"	7.87	200	10.31	262	10.70	272	1"	0.79	20	2.01	51	4.25	108	0.56	14.2	3.13	79.4	0.63	16	04	0.138	3.5	1.97	50	9.02	229	
8"	7.87	200	10.31	262	10.70	272	1.5"	1.34	34	2.87	73	5.00	127	0.69	17.5	3.87	98.4	0.63	16	04	0.138	3.5	1.97	75	9.02	229	
8"	7.87	200	10.31	262	10.70	272	2"	1.73	44	3.62	92	6.00	152.4	0.75	19	4.75	120.6	0.75	19	04	0.157	4	1.97	90	9.02	229	

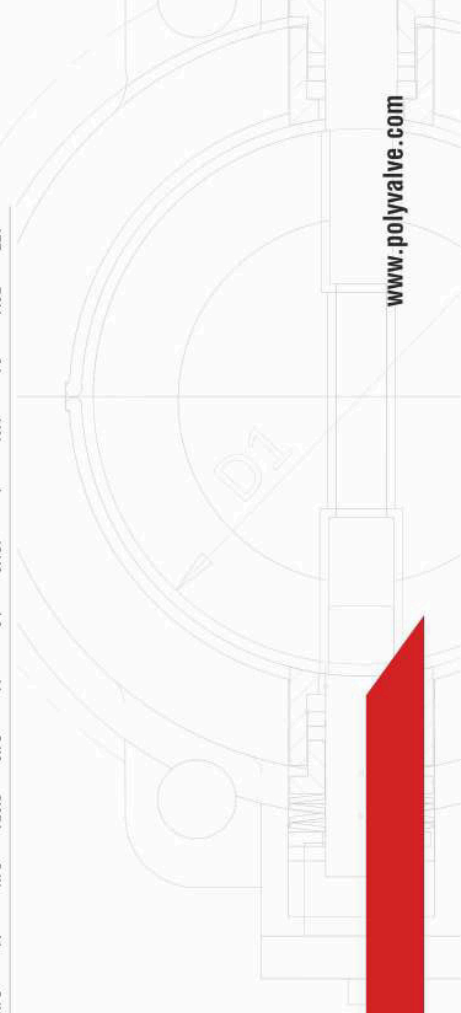

BLIND FLANGE

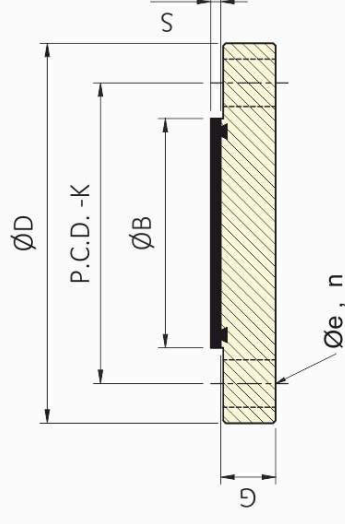
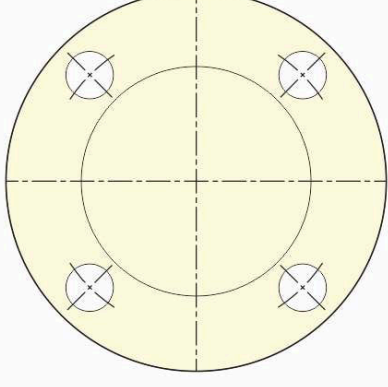

Material Specifications

1. Flange : ASTM A 105 - 150#
2. Lining : PFA conforming ASTM D3307

Dimension Specifications

1. All dimensions are in mm.
2. Flange as per ANSI B16.5, 150#
3. Lining and other dimensional tolerances as per ASTM F1545

Testing

1. 100% Visual Check
2. 100% Dimensional Check
3. 100% Spark Test At 15 KVDC. (after Lining)

DIMENSION TABLE

Size	ØR/F (ØB)		E. OD (ØD)		F. THK (G)		P.C.D. (K)		H - DIA (Øe)		NH (n)		LINING THK (S)	
	INCH	MM	INCH	MM	INCH	MM	INCH	MM	INCH	MM	INCH	MM	INCH	MM
1/2"	0.079 ±2	34.9	3.50	88.9	0.44	11.1	2.37	60.3	0.63	15.9	04	0.126	3.2	
3/4"		42.7	3.87	98.4	0.50	12.7	2.75	69.8	0.63	15.9	04	0.126	3.2	
1"		51	4.25	108	0.56	14.2	3.13	79.4	0.63	15.9	04	0.138	3.5	
1.5		73	5.00	127	0.69	17.5	3.87	98.4	0.63	15.9	04	0.138	3.5	
2"		92	6.00	152.4	0.75	19.1	4.75	120.6	0.75	19	04	0.157	4	
3"		127	7.50	190.5	0.94	23.8	6.00	152.4	0.75	19	04	0.177	4.5	
4"		157	9.00	228.6	0.94	23.8	7.50	190.5	0.75	19	08	0.177	4.5	
6"		216	11.00	279.4	1.00	25.4	9.50	241.3	0.87	22.2	08	0.177	4.5	
8"		270	13.50	342.9	1.13	28.6	11.75	298.4	0.87	22.2	08	0.177	4.5	
10"		324	16.00	406.4	1.19	30.2	14.25	362	1.00	25.4	12	0.217	5.5	
12"		381	19.00	482.6	1.25	31.8	17.00	431.8	1.00	25.4	12	0.217	5.5	
14"		413	21.00	533.4	1.37	34.9	18.75	476.3	1.13	28.6	12	0.256	6.5	
16"		470	23.50	596.9	1.44	36.5	21.25	539.8	1.13	28.6	16	0.256	6.5	
18"		533.4	25.00	635	1.56	39.7	22.75	577.9	1.25	31.8	16	0.256	6.5	
20"		584.2	27.50	698.5	1.69	42.9	25.00	635	1.26	32	20	0.256	6.5	

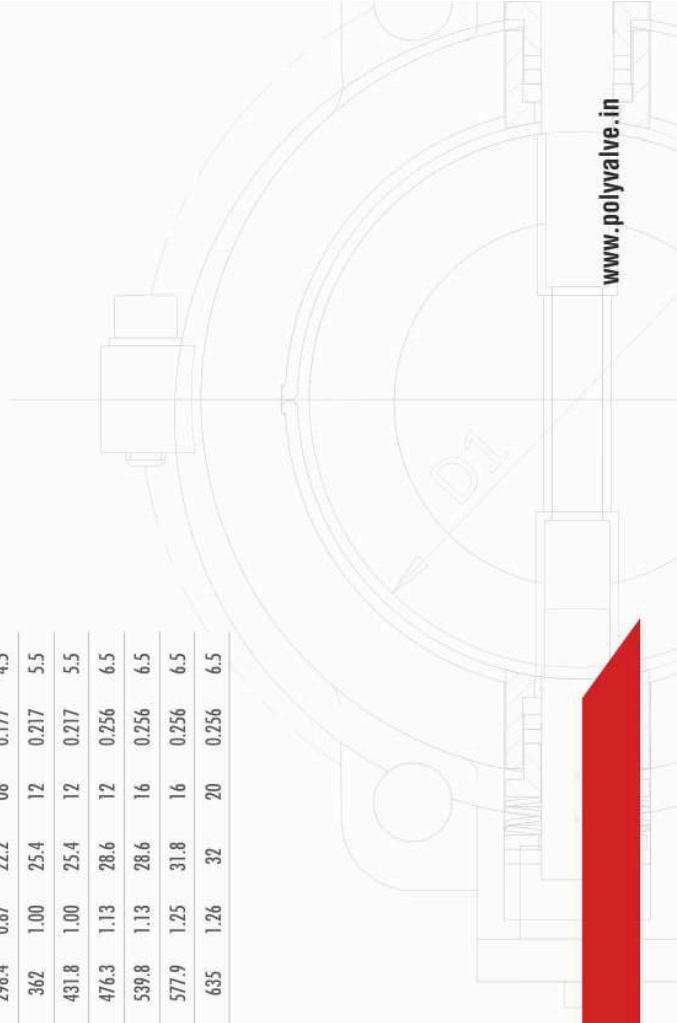

SPECTACLE BLIND FLANGE

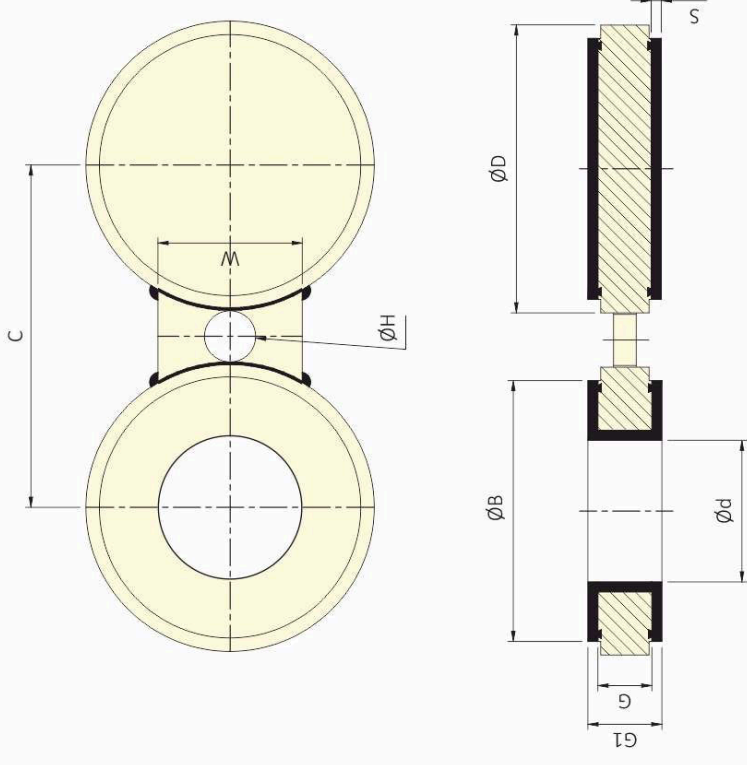

Material Specifications

1. Flange : ASTM A 105 - 150#
2. Lining : PFA conforming ASTM D3307

Dimension Specifications

1. All dimensions are in mm.
2. Flange as per ANSI B16.5, 150#
3. Lining and other dimensional tolerances as per ASTM F1545

Testing

1. 100% Visual Check
2. 100% Dimensional Check
3. 100% Spark Test At 15 KVDC. (after Lining)

DIMENSION TABLE

Size	ØD		ØB		Ød		G		G1		C		W		ØH		S	
	INCH	MM	INCH	MM	INCH	MM	INCH	MM	INCH	MM	INCH	MM	INCH	MM	INCH	MM	INCH	MM
1"	2.5	63.5	2.01	51	0.79	20	0.56	14.3	0.83	21	3.13	79.4	1.50	38	0.55	14	0.14	3.5
1.5"	3.25	82.5	2.87	73	1.34	34	0.69	17.5	0.96	24.5	3.87	98.4	1.50	38	0.55	14	0.14	3.5
2"	4.00	101.5	3.62	92	1.73	44	0.75	19	1.06	27	4.75	120.6	1.97	50	0.71	18	0.16	4
3"	5.26	133.5	5.00	127	2.76	70	0.94	23.8	1.30	33	6.00	152.4	2.52	64	0.71	18	0.18	4.5
4"	6.75	171.5	6.18	157	3.70	94	0.94	23.8	1.30	33	7.50	190.5	2.52	64	0.71	18	0.18	4.5
6"	8.62	219	8.43	214	5.67	144	1.00	25.4	1.34	34	9.50	241.3	2.99	76	0.87	22	0.18	4.5
8"	10.89	276.5	10.63	270	7.56	192	1.13	28.6	1.46	37	11.75	298.4	2.99	76	0.87	22	0.18	4.5
10"	13.25	336.5	12.76	324	9.57	243	1.19	30.2	1.54	39	14.25	362	4.02	102	0.98	25	0.18	4.5
12"	16.00	406.5	15.00	381	11.54	293	1.25	31.8	1.61	41	17.01	432	4.02	102	0.98	25	0.18	4.5
14"	17.62	447.5	16.26	413	12.68	322	1.37	34.9	1.73	44	18.74	476	4.25	108	1.10	28	0.18	4.5



CONCENTRIC REDUCER

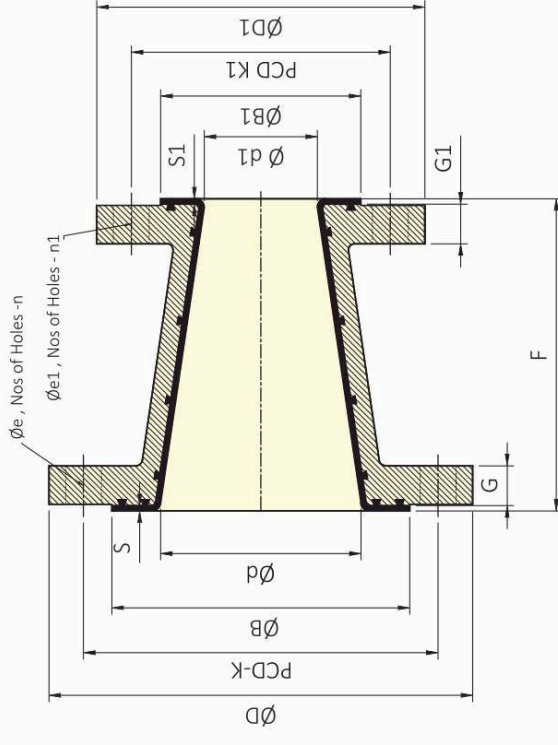

Material Specifications

1. Con. reducer : ASTM A 216 GR. WCB
2. Flange : As per ANSI B 16.5, 150#
3. Lining : PFA conforming ASTM D 3307

Dimension Specifications

1. All dimensions are in mm.
2. Flange as per ANSI B16.5, 150#
3. Lining and other dimensional tolerances as per ASTM F1545
4. Lining face thickness 80% of min. liner wall Thk.

Testing

1. 100% Visual Check
2. 100% Dimensional Check
3. 100% Spark Test At 15 KVDC.
4. 100% Hydro Test At 29 kg/cm² holding time 3 min., as per ASTM F1545 (after Lining)

ECCENTRIC REDUCER

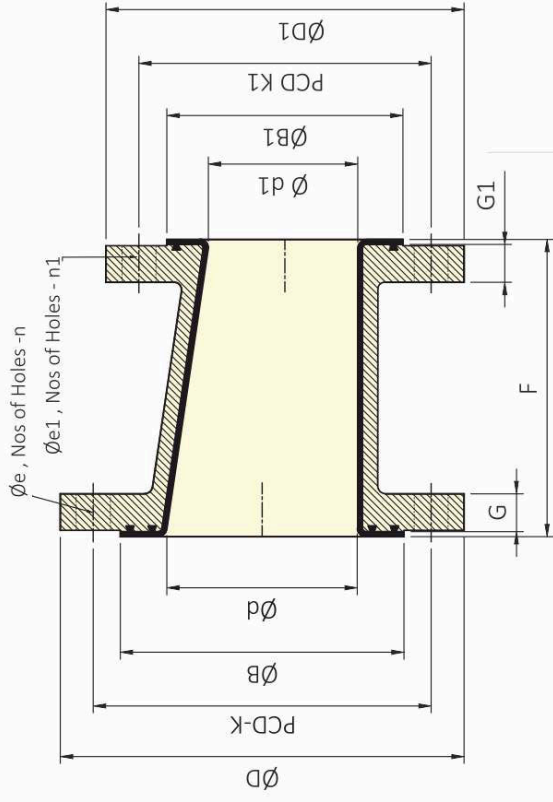

Material Specifications

1. Ecc. reducer : ASTM A 216 GR. WCB
2. Flange : As per ANSI B 16.5, 150#
3. Lining : PFA conforming ASTM D 3307

Dimension Specifications

1. All dimensions are in mm.
2. Flange as per ANSI B16.5, 150#
3. Lining and other dimensional tolerances as per ASTM F1545
4. Lining face thickness 80% of min. liner wall Thk.

Testing

1. 100% Visual Check
2. 100% Dimensional Check
3. 100% Spark Test At 15 KVDC.
4. 100% Hydro Test At 29 kg/cm² holding time 3 min., as per ASTM F1545 (after Lining)



UNPP Polyvalves

DIMENSION TABLE

Size	L - ID (Ød)		ØR/F (ØB)		E. OD (ØD)		E. THK (G)		P.C.D. (K)		H - DIA (Øa)		NH (n)		LINING THK (S)		Size	L - ID (Ød)		ØR/F (ØB)		E. OD (ØD)		E. THK (G)		P.C.D. (K)		H - DIA (Øa)		NH (n)		LINING THK (S)		F
	MM	INCH	MM	INCH	MM	INCH	MM	INCH	MM	INCH	MM	INCH	MM	INCH	MM	INCH		MM	INCH	MM	INCH	MM	INCH	MM	INCH	MM	INCH	MM	INCH	MM	INCH	MM	INCH	
3/4"	0.59	15	1.48	42.7	3.87	98.4	0.50	12.7	2.75	69.8	0.63	15.9	0.4	0.126	3.2	1/2"	0.39	10	1.37	34.9	3.50	88.9	0.44	11.1	2.37	60.3	0.63	15.9	0.4	0.126	3.2	4.49	114	
1"	0.79	20	2.01	51	4.25	108	0.56	14.2	3.13	79.4	0.63	15.9	0.4	0.138	3.5	1/2"	0.39	10	1.37	34.9	3.50	88.9	0.44	11.1	2.37	60.3	0.63	15.9	0.4	0.126	3.2	4.49	114	
1"	0.79	20	2.01	51	4.25	108	0.56	14.2	3.13	79.4	0.63	15.9	0.4	0.138	3.5	3/4"	0.59	15	1.68	42.7	3.87	98.4	0.50	12.7	2.75	69.8	0.63	15.9	0.4	0.126	3.2	4.49	114	
1.5"	1.34	34	2.87	73	5.00	127	0.69	17.5	3.87	98.4	0.63	15.9	0.4	0.138	3.5	3/4"	0.59	15	1.68	42.7	3.87	98.4	0.50	12.7	2.75	69.8	0.63	15.9	0.4	0.126	3.2	4.49	114	
1.5"	1.34	34	2.87	73	5.00	127	0.69	17.5	3.87	98.4	0.63	15.9	0.4	0.138	3.5	1"	0.79	20	2.01	51	4.25	108	0.56	14.2	3.13	79.4	0.63	15.9	0.4	0.138	3.5	4.49	114	
2"	1.73	44	3.62	92	6.00	152.4	0.75	19	4.75	120.6	0.75	19	0.4	0.157	4	3/4"	0.59	15	1.68	42.7	3.87	98.4	0.50	12.7	2.75	69.8	0.63	15.9	0.4	0.126	3.2	5.00	127	
2"	1.73	44	3.62	92	6.00	152.4	0.75	19	4.75	120.6	0.75	19	0.4	0.157	4	1"	0.79	20	2.01	51	4.25	108	0.56	14.2	3.13	79.4	0.63	15.9	0.4	0.138	3.5	5.00	127	
2"	1.73	44	3.62	92	6.00	152.4	0.75	19	4.75	120.6	0.75	19	0.4	0.157	4	1.5"	1.34	34	2.87	73	5.00	127	0.69	17.5	3.87	98.4	0.63	15.9	0.4	0.138	3.5	5.00	127	
3"	2.76	70	5.00	127	7.50	190.5	0.94	23.8	6.00	152.4	0.75	19	0.4	0.177	4.5	1"	0.79	20	2.01	51	4.25	108	0.56	14.2	3.13	79.4	0.63	15.9	0.4	0.138	3.5	5.98	152	
3"	2.76	70	5.00	127	7.50	190.5	0.94	23.8	6.00	152.4	0.75	19	0.4	0.177	4.5	1.5"	1.34	34	2.87	73	5.00	127	0.69	17.5	3.87	98.4	0.63	15.9	0.4	0.138	3.5	5.98	152	
3"	2.76	70	5.00	127	7.50	190.5	0.94	23.8	6.00	152.4	0.75	19	0.4	0.177	4.5	2"	1.73	44	3.62	92	6.00	152.4	0.75	19	4.57	120.6	0.75	19	0.4	0.157	4	5.98	152	
4"	3.70	94	6.18	157	9.00	228.6	0.94	23.8	7.50	190.5	0.75	19	0.8	0.177	4.5	1"	0.79	20	2.01	51	4.25	108	0.56	14.2	3.13	79.4	0.63	15.9	0.4	0.138	3.5	7.01	178	
4"	3.70	94	6.18	157	9.00	228.6	0.94	23.8	7.50	190.5	0.75	19	0.8	0.177	4.5	1.5"	1.34	34	2.87	73	5.00	127	0.69	17.5	3.87	98.4	0.63	15.9	0.4	0.138	3.5	7.01	178	
4"	3.70	94	6.18	157	9.00	228.6	0.94	23.8	7.50	190.5	0.75	19	0.8	0.177	4.5	2"	1.73	44	3.62	92	6.00	152.4	0.75	19	4.75	120.6	0.75	19	0.4	0.157	4	7.01	178	
4"	3.70	94	6.18	157	9.00	228.6	0.94	23.8	7.50	190.5	0.75	19	0.8	0.177	4.5	3"	2.76	70	5.00	127	7.50	190.5	0.94	23.8	6.00	152.4	0.75	19	0.4	0.177	4.5	7.01	178	
6"	5.67	144	8.50	216	11.00	279.4	1.00	25.4	9.50	241.3	0.87	22.2	0.8	0.177	4.5	1"	0.79	20	2.01	51	4.25	108	0.56	14.2	3.13	79.4	0.63	15.9	0.4	0.138	3.5	9.02	229	
6"	5.67	144	8.50	216	11.00	279.4	1.00	25.4	9.50	241.3	0.87	22.2	0.8	0.177	4.5	1.5"	1.34	34	2.87	73	5.00	127	0.69	17.5	3.87	98.4	0.63	15.9	0.4	0.138	3.5	9.02	229	
6"	5.67	144	8.50	216	11.00	279.4	1.00	25.4	9.50	241.3	0.87	22.2	0.8	0.177	4.5	2"	1.73	44	3.62	92	6.00	152.4	0.75	19	4.75	120.6	0.75	19	0.4	0.157	4	9.02	229	
6"	5.67	144	8.50	216	11.00	279.4	1.00	25.4	9.50	241.3	0.87	22.2	0.8	0.177	4.5	3"	2.76	70	5.00	127	7.50	190.5	0.94	23.8	6.00	152.4	0.75	19	0.4	0.177	4.5	9.02	229	
6"	5.67	144	8.50	216	11.00	279.4	1.00	25.4	9.50	241.3	0.87	22.2	0.8	0.177	4.5	4"	3.70	94	6.18	157	9.00	228.6	0.94	23.8	7.50	190.5	0.75	19	0.8	0.177	4.5	9.02	229	
8"	7.64	194	10.63	270	13.50	342.9	1.13	28.6	11.75	298.4	0.87	22.2	0.8	0.177	4.5	1.5"	1.34	34	2.87	73	5.00	127	0.69	17.5	3.87	98.4	0.63	15.9	0.4	0.138	3.5	10.98	279	
8"	7.64	194	10.63	270	13.50	342.9	1.13	28.6	11.75	298.4	0.87	22.2	0.8	0.177	4.5	2"	1.73	44	3.62	92	6.00	152.4	0.75	19	4.75	120.6	0.75	19	0.4	0.157	4	10.98	279	
8"	7.64	194	10.63	270	13.50	342.9	1.13	28.6	11.75	298.4	0.87	22.2	0.8	0.177	4.5	3"	2.76	70	5.00	127	7.50	190.5	0.94	23.8	6.00	152.4	0.75	19	0.4	0.177	4.5	10.98	279	
8"	7.64	194	10.63	270	13.50	342.9	1.13	28.6	11.75	298.4	0.87	22.2	0.8	0.177	4.5	4"	3.70	94	6.18	157	9.00	228.6	0.94	23.8	7.50	190.5	0.75	19	0.8	0.177	4.5	10.98	279	
8"	7.64	194	10.63	270	13.50	342.9	1.13	28.6	11.75	298.4	0.87	22.2	0.8	0.177	4.5	6"	5.67	144	8.50	216	11.00	279.4	1.00	25.4	9.50	241.3	0.87	22.2	0.8	0.177	4.5	10.98	279	
10"	9.53	242	12.76	324	16.00	406.4	1.19	30.2	14.25	362	1.00	25.4	12	0.217	5.5	1.5"	1.34	34	2.87	73	5.00	127	0.69	17.5	3.87	98.4	0.63	15.9	0.4	0.138	3.5	12.01	305	
10"	9.53	242	12.76	324	16.00	406.4	1.19	30.2	14.25	362	1.00	25.4	12	0.217	5.5	2"	1.73	44	3.62	92	6.00	152.4	0.75	19	4.75	120.6	0.75	19	0.4	0.157	4	12.01	305	
10"	9.53	242	12.76	324	16.00	406.4	1.19	30.2	14.25	362	1.00	25.4	12	0.217	5.5	3"	2.76	70	5.00	127	7.50	190.5	0.94	23.8	6.00	152.4	0.75	19	0.4	0.177	4.5	12.01	305	
10"	9.53	242	12.76	324	16.00	406.4	1.19	30.2	14.25	362	1.00	25.4	12	0.217	5.5	4"	3.70	94	6.18	157	9.00	228.6	0.94	23.8	7.50	190.5	0.75	19	0.8	0.177	4.5	12.01	305	
10"	9.53	242	12.76	324	16.00	406.4	1.19	30.2	14.25	362	1.00	25.4	12	0.217	5.5	6"	5.67	144	8.50	216	11.00	279.4	1.00	25.4	9.50	241.3	0.87	22.2	0.8	0.177	4.5	12.01	305	
10"	9.53	242	12.76	324	16.00	406.4	1.19	30.2	14.25	362	1.00	25.4	12	0.217	5.5	8"	7.64	194	10.63	270	13.50	342.9	1.13	28.6	11.75	298.4	0.87	22.2	0.8	0.177	4.5	12.01	305	

DIMENSION TABLE

Size	L - ID (∅d)		∅R/F (∅B)		E. OD (∅D)		E. THK (G)		P.C.D. (K)		H - DIA (∅e)		NH (n)		LINING THK (S)		Size	L - ID (∅d1)		∅R/F (∅B1)		E. OD (∅D1)		E. THK (G1)		P.C.D. (K1)		H - DIA (∅e1)		NH (n1)		LINING THK (S1)		F
	INCH	MM	INCH	MM	INCH	MM	INCH	MM	INCH	MM	INCH	MM	INCH	MM	INCH	MM		INCH	MM	INCH	MM	INCH	MM	INCH	MM	INCH	MM	INCH	MM	INCH	MM	INCH	MM	
12"	11.46	291	15.00	381	19.00	482.6	1.25	31.8	17.00	431.8	1.00	25.4	12	0.217	5.5	1.5"	1.34	34	2.87	73	5.00	127	0.69	17.5	3.87	98.4	0.63	15.9	04	0.138	3.5	14.02	356	
12"	11.46	291	15.00	381	19.00	482.6	1.25	31.8	17.00	431.8	1.00	25.4	12	0.217	5.5	2"	1.73	44	3.62	92	6.00	152.4	0.75	19	4.75	120.6	0.75	19	04	0.157	4	14.02	356	
12"	11.46	291	15.00	381	19.00	482.6	1.25	31.8	17.00	431.8	1.00	25.4	12	0.217	5.5	3"	2.76	70	5.00	127	7.50	190.5	0.94	23.8	6.00	152.4	0.75	19	04	0.177	4.5	14.02	356	
12"	11.46	291	15.00	381	19.00	482.6	1.25	31.8	17.00	431.8	1.00	25.4	12	0.217	5.5	4"	3.70	94	6.18	157	9.00	228.6	0.94	23.8	7.50	190.5	0.75	19	08	0.177	4.5	14.02	356	
12"	11.46	291	15.00	381	19.00	482.6	1.25	31.8	17.00	431.8	1.00	25.4	12	0.217	5.5	6"	5.67	144	8.50	216	11.00	279.4	1.00	25.4	9.50	241.3	0.87	22.2	08	0.177	4.5	14.02	356	
12"	11.46	291	15.00	381	19.00	482.6	1.25	31.8	17.00	431.8	1.00	25.4	12	0.217	5.5	8"	7.54	191.5	10.63	270	13.50	342.9	1.13	28.6	11.75	298.4	0.87	22.2	08	0.177	4.5	14.02	356	
12"	11.46	291	15.00	381	19.00	482.6	1.25	31.8	17.00	431.8	1.00	25.4	12	0.217	5.5	10"	9.53	242	12.76	324	16.00	406.4	1.19	30.2	14.25	362	1.00	25.4	12	0.217	5.5	14.02	356	
14"	12.64	321	16.26	413	21.00	533.4	1.37	34.9	18.75	476.3	1.13	28.6	12	0.256	6.5	1.5"	1.34	34	2.87	73	5.00	127	0.69	17.5	3.87	98.4	0.63	15.9	04	0.138	3.5	15.98	406	
14"	12.64	321	16.26	413	21.00	533.4	1.37	34.9	18.75	476.3	1.13	28.6	12	0.256	6.5	2"	1.73	44	3.62	92	6.00	152.4	0.75	19	4.75	120.6	0.75	19	04	0.157	4	15.98	406	
14"	12.64	321	16.26	413	21.00	533.4	1.37	34.9	18.75	476.3	1.13	28.6	12	0.256	6.5	3"	2.76	70	5.00	127	7.50	190.5	0.94	23.8	6.00	152.4	0.75	19	04	0.177	4.5	15.98	406	
14"	12.64	321	16.26	413	21.00	533.4	1.37	34.9	18.75	476.3	1.13	28.6	12	0.256	6.5	4"	3.70	94	6.18	157	9.00	228.6	0.94	23.8	7.50	190.5	0.75	19	08	0.177	4.5	15.98	406	
14"	12.64	321	16.26	413	21.00	533.4	1.37	34.9	18.75	476.3	1.13	28.6	12	0.256	6.5	6"	5.67	144	8.50	216	11.00	279.4	1.00	25.4	9.50	241.3	0.87	22.2	08	0.177	4.5	15.98	406	
14"	12.64	321	16.26	413	21.00	533.4	1.37	34.9	18.75	476.3	1.13	28.6	12	0.256	6.5	8"	7.54	191.5	10.63	270	13.50	342.9	1.13	28.6	11.75	298.4	0.87	22.2	08	0.177	4.5	15.98	406	
14"	12.64	321	16.26	413	21.00	533.4	1.37	34.9	18.75	476.3	1.13	28.6	12	0.256	6.5	10"	9.53	242	12.76	324	16.00	406.4	1.19	30.2	14.25	362	1.00	25.4	12	0.217	5.5	15.98	406	
14"	12.64	321	16.26	413	21.00	533.4	1.37	34.9	18.75	476.3	1.13	28.6	12	0.256	6.5	12"	11.46	291	15.00	381	19.00	482.6	1.25	31.8	17.00	431.8	1.00	25.4	12	0.217	5.5	15.98	406	



UNEQUAL TEES

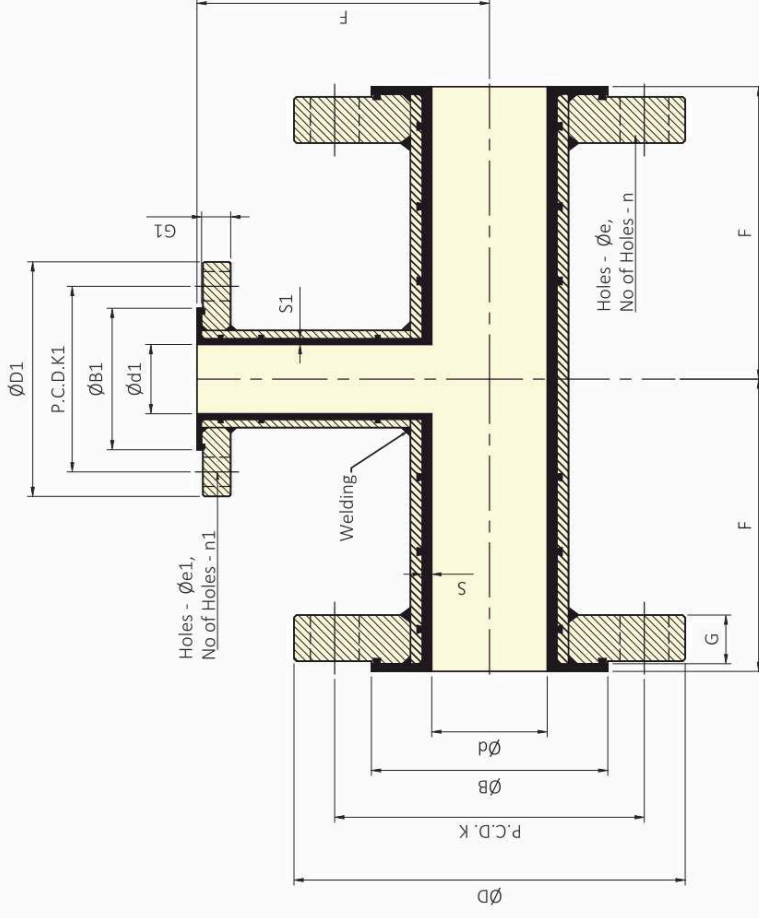

Material Specifications

1. UN.EQ.TEE : Made From Fabrication Seamless Carbon Steel Pipe:
As per ASTM A 106 GR.B, SCH 40 (upto 6")
As per ASTM A 106 GR.B, SCH 20 (above 6")
2. Flange : ASTM A 105 as per ANSI B 16.5, 150#
3. Liner : PFA conforming ASTM D 3307

Dimension Specifications

1. All dimensions are in mm.
2. Pipe as per ANSI B36.10
3. Flange as per ANSI B16.5, 150#
4. Lining and other dimensional tolerances as per ASTM F1545

Testing

1. 100% Visual Check
2. 100% Dimensional Check
3. 100% Spark Test At 15 KVDC.
4. 100% Hydro Test At 29 kg/cm² holding time 3 min., as per ASTM F1545 (after Lining)

DIMENSION TABLE

Size	L - ID (ØD)		ØR / F (ØB)		E. OD (ØD)		E. THK (G)		P.C.D. (K)		H - DIA (Øe)		NH (n)		LINING THK (S)		Size	L - ID (ØB1)		ØR / F (ØB1)		E. OD (ØD1)		E. THK (G1)		P.C.D. (K1)		H - DIA (Øe1)		NH (n1)		LINING THK (S1)		F	C.S. PIPE (SCH)
	INCH	MM	INCH	MM	INCH	MM	INCH	MM	INCH	MM	INCH	MM	INCH	MM	INCH	MM		INCH	MM	INCH	MM	INCH	MM	INCH	MM	INCH	MM	INCH	MM	INCH	MM	INCH	MM		
3/4"	0.59	15	1.68	42.7	3.87	98.4	0.50	12.7	2.75	69.8	0.63	15.9	0.4	0.126	3.2	1/2"	0.39	10	1.37	34.9	3.50	88.9	0.44	11.1	2.37	60.3	0.63	15.9	0.4	0.126	3.2	2.95	75	40	
1"	0.79	20	2.01	51	4.25	108	0.56	14.2	3.13	79.4	0.63	15.9	0.4	0.138	3.5	1/2"	0.39	10	1.37	34.9	3.50	88.9	0.44	11.1	2.37	60.3	0.63	15.9	0.4	0.126	3.2	3.50	89	40	
1"	0.79	20	2.01	51	4.25	108	0.56	14.2	3.13	79.4	0.63	15.9	0.4	0.138	3.5	3/4"	0.59	15	1.68	42.7	3.87	98.4	0.50	12.7	2.75	69.8	0.63	15.9	0.4	0.126	3.2	3.50	89	40	
1.5"	1.34	34	2.87	73	5.00	127	0.69	17.5	3.87	98.4	0.63	15.9	0.4	0.138	3.5	3/4"	0.59	15	1.68	42.7	3.87	98.4	0.50	12.7	2.75	69.8	0.63	15.9	0.4	0.126	3.2	4.02	102	40	
1.5"	1.34	34	2.87	73	5.00	127	0.69	17.5	3.87	98.4	0.63	15.9	0.4	0.138	3.5	1"	0.79	20	2.01	51	4.25	108	0.56	14.2	3.13	79.4	0.63	15.9	0.4	0.138	3.5	4.02	102	40	
2"	1.73	44	3.62	92	6.00	152.4	0.75	19	4.75	120.6	0.75	19	0.4	0.157	4	3/4"	0.59	15	1.68	42.7	3.87	98.4	0.50	12.7	2.75	69.8	0.63	15.9	0.4	0.126	3.2	4.49	114	40	
2"	1.73	44	3.62	92	6.00	152.4	0.75	19	4.75	120.6	0.75	19	0.4	0.157	4	1"	0.79	20	2.01	51	4.25	108	0.56	14.2	3.13	79.4	0.63	15.9	0.4	0.138	3.5	4.49	114	40	
2"	1.73	44	3.62	92	6.00	152.4	0.75	19	4.75	120.6	0.75	19	0.4	0.157	4	1.5"	1.34	34	2.87	73	5.00	127	0.69	17.5	3.87	98.4	0.63	15.9	0.4	0.138	3.5	4.49	114	40	
3"	2.76	70	5.00	127	7.50	190.5	0.94	23.8	6.00	152.4	0.75	19	0.4	0.177	4.5	1"	0.79	20	2.01	51	4.25	108	0.56	14.2	3.13	79.4	0.63	15.9	0.4	0.138	3.5	5.51	140	40	
3"	2.76	70	5.00	127	7.50	190.5	0.94	23.8	6.00	152.4	0.75	19	0.4	0.177	4.5	1.5"	1.34	34	2.87	73	5.00	127	0.69	17.5	3.87	98.4	0.63	15.9	0.4	0.138	3.5	5.51	140	40	
3"	2.76	70	5.00	127	7.50	190.5	0.94	23.8	6.00	152.4	0.75	19	0.4	0.177	4.5	2"	1.73	44	3.62	92	6.00	152.4	0.75	19	4.57	120.6	0.75	19	0.4	0.157	4	5.51	140	40	
4"	3.70	94	6.18	157	9.00	228.6	0.94	23.8	7.50	190.5	0.75	19	0.8	0.177	4.5	1"	0.79	20	2.01	51	4.25	108	0.56	14.2	3.13	79.4	0.63	15.9	0.4	0.138	3.5	6.50	165	40	
4"	3.70	94	6.18	157	9.00	228.6	0.94	23.8	7.50	190.5	0.75	19	0.8	0.177	4.5	1.5"	1.34	34	2.87	73	5.00	127	0.69	17.5	3.87	98.4	0.63	15.9	0.4	0.138	3.5	6.50	165	40	
4"	3.70	94	6.18	157	9.00	228.6	0.94	23.8	7.50	190.5	0.75	19	0.8	0.177	4.5	2"	1.73	44	3.62	92	6.00	152.4	0.75	19	4.75	120.6	0.75	19	0.4	0.157	4	6.50	165	40	
4"	3.70	94	6.18	157	9.00	228.6	0.94	23.8	7.50	190.5	0.75	19	0.8	0.177	4.5	3"	2.76	70	5.00	127	7.50	190.5	0.94	23.8	6.00	152.4	0.75	19	0.4	0.177	4.5	6.50	165	40	
6"	5.67	144	8.50	216	11.00	279.4	1.00	25.4	9.50	241.3	0.87	22.2	0.8	0.177	4.5	1"	0.79	20	2.01	51	4.25	108	0.56	14.2	3.13	79.4	0.63	15.9	0.4	0.138	3.5	7.99	203	40	
6"	5.67	144	8.50	216	11.00	279.4	1.00	25.4	9.50	241.3	0.87	22.2	0.8	0.177	4.5	1.5"	1.34	34	2.87	73	5.00	127	0.69	17.5	3.87	98.4	0.63	15.9	0.4	0.138	3.5	7.99	203	40	
6"	5.67	144	8.50	216	11.00	279.4	1.00	25.4	9.50	241.3	0.87	22.2	0.8	0.177	4.5	2"	1.73	44	3.62	92	6.00	152.4	0.75	19	4.75	120.6	0.75	19	0.4	0.157	4	7.99	203	40	
6"	5.67	144	8.50	216	11.00	279.4	1.00	25.4	9.50	241.3	0.87	22.2	0.8	0.177	4.5	3"	2.76	70	5.00	127	7.50	190.5	0.94	23.8	6.00	152.4	0.75	19	0.4	0.177	4.5	7.99	203	40	
6"	5.67	144	8.50	216	11.00	279.4	1.00	25.4	9.50	241.3	0.87	22.2	0.8	0.177	4.5	4"	3.70	94	6.18	157	9.00	228.6	0.94	23.8	7.50	190.5	0.75	19	0.4	0.177	4.5	7.99	203	40	
8"	7.64	194	10.63	270	13.50	342.9	1.13	28.6	11.75	298.4	0.87	22.2	0.8	0.177	4.5	1.5"	1.34	34	2.87	73	5.00	127	0.69	17.5	3.87	98.4	0.63	15.9	0.4	0.138	3.5	9.02	229	20	
8"	7.64	194	10.63	270	13.50	342.9	1.13	28.6	11.75	298.4	0.87	22.2	0.8	0.177	4.5	2"	1.73	44	3.62	92	6.00	152.4	0.75	19	4.75	120.6	0.75	19	0.4	0.157	4	9.02	229	20	
8"	7.64	194	10.63	270	13.50	342.9	1.13	28.6	11.75	298.4	0.87	22.2	0.8	0.177	4.5	3"	2.76	70	5.00	127	7.50	190.5	0.94	23.8	6.00	152.4	0.75	19	0.4	0.177	4.5	9.02	229	20	
8"	7.64	194	10.63	270	13.50	342.9	1.13	28.6	11.75	298.4	0.87	22.2	0.8	0.177	4.5	4"	3.70	94	6.18	157	9.00	228.6	0.94	23.8	7.50	190.5	0.75	19	0.4	0.177	4.5	9.02	229	20	
8"	7.64	194	10.63	270	13.50	342.9	1.13	28.6	11.75	298.4	0.87	22.2	0.8	0.177	4.5	6"	5.67	144	8.50	216	11.00	279.4	1.00	25.4	9.50	241.3	0.87	22.2	0.8	0.177	4.5	9.02	229	20	
10"	9.53	242	12.76	324	16.00	406.4	1.19	30.2	14.25	362	1.00	25.4	12	0.217	5.5	1.5"	1.34	34	2.87	73	5.00	127	0.69	17.5	3.87	98.4	0.63	15.9	0.4	0.138	3.5	10.98	279	20	
10"	9.53	242	12.76	324	16.00	406.4	1.19	30.2	14.25	362	1.00	25.4	12	0.217	5.5	2"	1.73	44	3.62	92	6.00	152.4	0.75	19	4.75	120.6	0.75	19	0.4	0.157	4	10.98	279	20	
10"	9.53	242	12.76	324	16.00	406.4	1.19	30.2	14.25	362	1.00	25.4	12	0.217	5.5	3"	2.76	70	5.00	127	7.50	190.5	0.94	23.8	6.00	152.4	0.75	19	0.4	0.177	4.5	10.98	279	20	
10"	9.53	242	12.76	324	16.00	406.4	1.19	30.2	14.25	362	1.00	25.4	12	0.217	5.5	4"	3.70	94	6.18	157	9.00	228.6	0.94	23.8	7.50	190.5	0.75	19	0.4	0.177	4.5	10.98	279	20	
10"	9.53	242	12.76	324	16.00	406.4	1.19	30.2	14.25	362	1.00	25.4	12	0.217	5.5	6"	5.67	144	8.50	216	11.00	279.4	1.00	25.4	9.50	241.3	0.87	22.2	0.8	0.177	4.5	10.98	279	20	
10"	9.53	242	12.76	324	16.00	406.4	1.19	30.2	14.25	362	1.00	25.4	12	0.217	5.5	8"	7.64	194	10.63	270	13.50	342.9	1.13	28.6	11.75	298.4	0.87	22.2	0.8	0.177	4.5	10.98	279	20	

DIMENSION TABLE

Size	L - ID (Ød)		ØR/F (ØB)		E. OD (ØD)		E. THK (G)		P.C.D. (K)		H - DIA (Øa)		NH (a)		LINING THK (S)		Size	L - ID (Ød)	ØR/F (ØB)		E. OD (ØD)		E. THK (G)		P.C.D. (K)		H - DIA (Øa)		NH (a)		LINING THK (S)		F	C.S. PIPE (SCH)
	INCH	MM	INCH	MM	INCH	MM	INCH	MM	INCH	MM	INCH	MM	INCH	MM	INCH	MM			INCH	MM	INCH	MM	INCH	MM	INCH	MM	INCH	MM	INCH	MM	INCH	MM		
12"	11.46	291	15.00	381	19.00	482.6	1.25	31.8	17.00	431.8	1.00	25.4	12	0.217	5.5	1.5"	1.34	34	2.87	73	5.00	127	0.69	17.5	3.87	98.4	0.63	15.9	04	0.138	3.5	12.01	305	20
12"	11.46	291	15.00	381	19.00	482.6	1.25	31.8	17.00	431.8	1.00	25.4	12	0.217	5.5	2"	1.73	44	3.62	92	6.00	152.4	0.75	19	4.75	120.6	0.75	19	04	0.157	4	12.01	305	20
12"	11.46	291	15.00	381	19.00	482.6	1.25	31.8	17.00	431.8	1.00	25.4	12	0.217	5.5	3"	2.76	70	5.00	127	7.50	190.5	0.94	23.8	6.00	152.4	0.75	19	04	0.177	4.5	12.01	305	20
12"	11.46	291	15.00	381	19.00	482.6	1.25	31.8	17.00	431.8	1.00	25.4	12	0.217	5.5	4"	3.70	94	6.18	157	9.00	228.6	0.94	23.8	7.50	190.5	0.75	19	08	0.177	4.5	12.01	305	20
12"	11.46	291	15.00	381	19.00	482.6	1.25	31.8	17.00	431.8	1.00	25.4	12	0.217	5.5	6"	5.67	144	8.50	216	11.00	279.4	1.00	25.4	9.50	241.3	0.87	22.2	08	0.177	4.5	12.01	305	20
12"	11.46	291	15.00	381	19.00	482.6	1.25	31.8	17.00	431.8	1.00	25.4	12	0.217	5.5	8"	7.64	194	10.63	270	13.50	342.9	1.13	28.6	11.75	298.4	0.87	22.2	08	0.177	4.5	12.01	305	20
12"	11.46	291	15.00	381	19.00	482.6	1.25	31.8	17.00	431.8	1.00	25.4	12	0.217	5.5	10"	9.53	242	12.76	324	16.00	406.4	1.19	30.2	14.25	362	1.00	25.4	12	0.217	5.5	12.01	305	20
14"	12.64	321	16.26	413	21.00	533.4	1.37	34.9	18.75	476.3	1.13	28.6	12	0.256	6.5	1.5"	1.34	34	2.87	73	5.00	127	0.69	17.5	3.87	98.4	0.63	15.9	04	0.138	3.5	14.02	356	20
14"	12.64	321	16.26	413	21.00	533.4	1.37	34.9	18.75	476.3	1.13	28.6	12	0.256	6.5	2"	1.73	44	3.62	92	6.00	152.4	0.75	19	4.75	120.6	0.75	19	04	0.157	4	14.02	356	20
14"	12.64	321	16.26	413	21.00	533.4	1.37	34.9	18.75	476.3	1.13	28.6	12	0.256	6.5	3"	2.76	70	5.00	127	7.50	190.5	0.94	23.8	6.00	152.4	0.75	19	04	0.177	4.5	14.02	356	20
14"	12.64	321	16.26	413	21.00	533.4	1.37	34.9	18.75	476.3	1.13	28.6	12	0.256	6.5	4"	3.70	94	6.18	157	9.00	228.6	0.94	23.8	7.50	190.5	0.75	19	08	0.177	4.5	14.02	356	20
14"	12.64	321	16.26	413	21.00	533.4	1.37	34.9	18.75	476.3	1.13	28.6	12	0.256	6.5	6"	5.67	144	8.50	216	11.00	279.4	1.00	25.4	9.50	241.3	0.87	22.2	08	0.177	4.5	14.02	356	20
14"	12.64	321	16.26	413	21.00	533.4	1.37	34.9	18.75	476.3	1.13	28.6	12	0.256	6.5	8"	7.64	194	10.63	270	13.50	342.9	1.13	28.6	11.75	298.4	0.87	22.2	08	0.177	4.5	14.02	356	20
14"	12.64	321	16.26	413	21.00	533.4	1.37	34.9	18.75	476.3	1.13	28.6	12	0.256	6.5	10"	9.53	242	12.76	324	16.00	406.4	1.19	30.2	14.25	362	1.00	25.4	12	0.217	5.5	14.02	356	20
14"	12.64	321	16.26	413	21.00	533.4	1.37	34.9	18.75	476.3	1.13	28.6	12	0.256	6.5	12"	11.46	291	15.00	381	19.00	482.6	1.25	31.8	17.00	431.8	1.00	25.4	12	0.217	5.5	14.02	356	20

REDUCING FLANGES

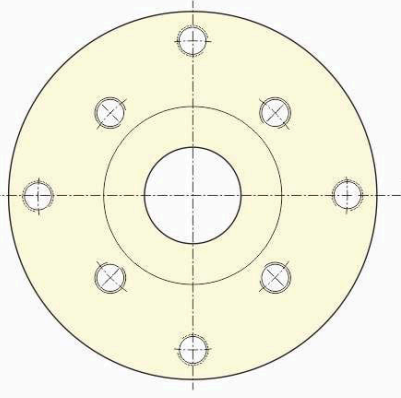
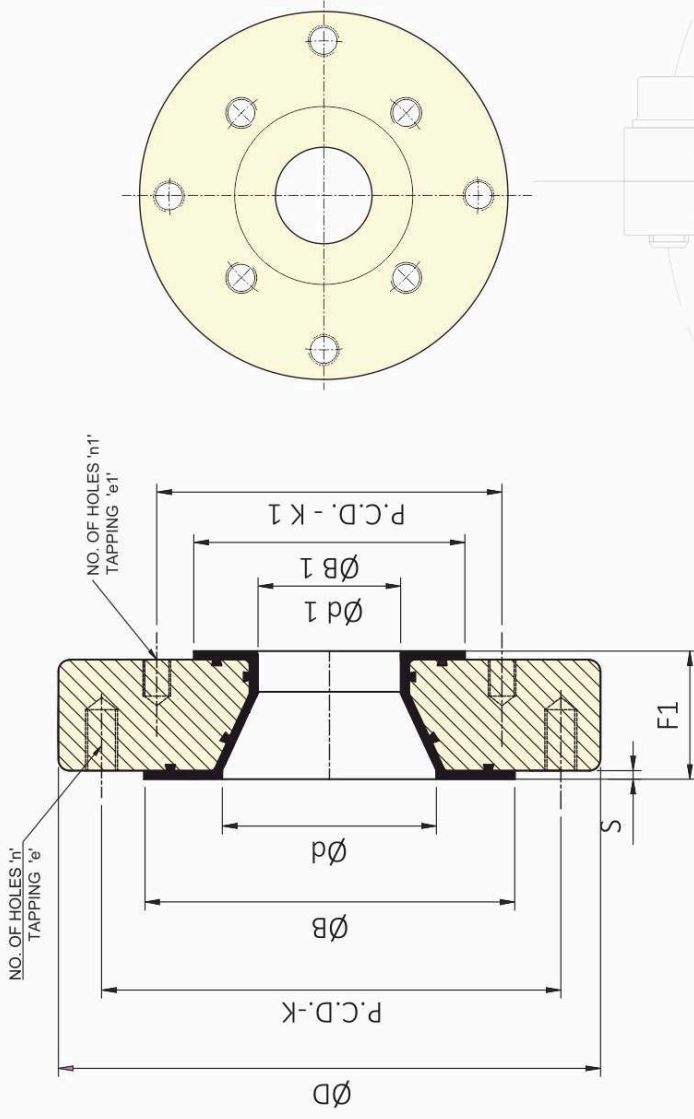

Material Specifications

1. Reducing Flange : IS 2062
2. Flange : As per ANSI B 16.5, 150#
3. Lining : PFA conforming ASTM D 3307

Dimension Specifications

1. All dimensions Are In mm.
3. Flange as per ANSI B16.5, 150#
5. Lining and other dimensional tolerances as per ASTM F1545

Testing

1. 100% Visual Check
2. 100% Dimensional Check
3. 100% Spark Test At 15 KVDC. (after Lining)

DIMENSION TABLE

Size	L - ID (∅d)		∅R/F (∅B)		F. OD (∅D)		P.C.D. (K)		UNC (∅e)		NH (n)		LINING THK (S)		L - ID (∅d1)		∅R/F (∅B1)		P.C.D. (K1)		UNC (∅e1)		NH (n1)		LINING THK (S)		F1)				
	INCH	MM	INCH	MM	INCH	MM	INCH	MM	INCH	MM	TAPPING		INCH	MM	INCH	MM	INCH	MM	INCH	MM	INCH	MM	TAPPING		INCH	MM	INCH	MM	INCH	MM	
10"	9.84	250	12.76	324	16.00	406.4	14.25	362	7/8"	12	0.217	5.5	1.5"	1.57	40	2.87	73	3.87	98.4	1/2"	04	0.138	3.5	2.13	35	0.079	±2	0.079	±2	0.06	±1.6
10"	9.84	250	12.76	324	16.00	406.4	14.25	362	7/8"	12	0.217	5.5	2"	1.97	50	3.62	92	4.75	120.6	5/8"	04	0.157	4	2.13	35	0.079	±2	0.079	±2	0.06	±1.6
10"	9.84	250	12.76	324	16.00	406.4	14.25	362	7/8"	12	0.217	5.5	3"	3.15	80	5.00	127	6.00	152.4	5/8"	04	0.177	4.5	2.13	35	0.079	±2	0.079	±2	0.06	±1.6
10"	9.84	250	12.76	324	16.00	406.4	14.25	362	7/8"	12	0.217	5.5	4"	3.94	100	6.18	157	7.50	190.5	5/8"	08	0.177	4.5	2.13	35	0.079	±2	0.079	±2	0.06	±1.6
10"	9.84	250	12.76	324	16.00	406.4	14.25	362	7/8"	12	0.217	5.5	6"	5.91	150	8.50	216	9.50	241.3	3/4"	08	0.177	4.5	2.13	35	0.079	±2	0.079	±2	0.06	±1.6
10"	9.84	250	12.76	324	16.00	406.4	14.25	362	7/8"	12	0.217	5.5	8"	7.87	200	10.63	270	11.75	298.4	3/4"	08	0.177	4.5	2.13	35	0.079	±2	0.079	±2	0.06	±1.6
12"	11.81	300	15.00	381	19.00	482.6	17.00	431.8	7/8"	12	0.217	5.5	1.5"	1.57	40	2.87	73	3.87	98.4	1/2"	04	0.138	3.5	2.13	35	0.079	±2	0.079	±2	0.06	±1.6
12"	11.81	300	15.00	381	19.00	482.6	17.00	431.8	7/8"	12	0.217	5.5	2"	1.97	50	3.62	92	4.75	120.6	5/8"	04	0.157	4	2.13	35	0.079	±2	0.079	±2	0.06	±1.6
12"	11.81	300	15.00	381	19.00	482.6	17.00	431.8	7/8"	12	0.217	5.5	3"	3.15	80	5.00	127	6.00	152.4	5/8"	04	0.177	4.5	2.13	35	0.079	±2	0.079	±2	0.06	±1.6
12"	11.81	300	15.00	381	19.00	482.6	17.00	431.8	7/8"	12	0.217	5.5	4"	3.94	100	6.18	157	7.50	190.5	5/8"	08	0.177	4.5	2.13	35	0.079	±2	0.079	±2	0.06	±1.6
12"	11.81	300	15.00	381	19.00	482.6	17.00	431.8	7/8"	12	0.217	5.5	6"	5.91	150	8.50	216	9.50	241.3	3/4"	08	0.177	4.5	2.13	35	0.079	±2	0.079	±2	0.06	±1.6
12"	11.81	300	15.00	381	19.00	482.6	17.00	431.8	7/8"	12	0.217	5.5	8"	7.87	200	10.63	270	11.75	298.4	3/4"	08	0.177	4.5	2.13	35	0.079	±2	0.079	±2	0.06	±1.6
12"	11.81	300	15.00	381	19.00	482.6	17.00	431.8	7/8"	12	0.217	5.5	10"	9.84	250	12.76	324	14.25	362	7/8"	12	0.217	5.5	2.13	35	0.079	±2	0.079	±2	0.06	±1.6
14"	13.78	350	16.26	413	21.00	533.4	18.75	476.3	1"	12	0.256	5.6	1.5"	1.57	40	2.87	73	3.87	98.4	1/2"	4	0.138	3.5	2.36	60	0.079	±2	0.079	±2	0.06	±1.6
14"	13.78	350	16.26	413	21.00	533.4	18.75	476.3	1"	12	0.256	5.6	2"	1.97	50	3.62	92	4.75	120.6	5/8"	4	0.157	4	2.36	60	0.079	±2	0.079	±2	0.06	±1.6
14"	13.78	350	16.26	413	21.00	533.4	18.75	476.3	1"	12	0.256	5.6	3"	3.15	80	5.00	127	6.00	152.4	5/8"	4	0.177	4.5	2.36	60	0.079	±2	0.079	±2	0.06	±1.6
14"	13.78	350	16.26	413	21.00	533.4	18.75	476.3	1"	12	0.256	5.6	4"	3.94	100	6.18	157	7.50	190.5	5/8"	8	0.177	4.5	2.36	60	0.079	±2	0.079	±2	0.06	±1.6
14"	13.78	350	16.26	413	21.00	533.4	18.75	476.3	1"	12	0.256	5.6	6"	5.91	150	8.50	216	9.50	241.3	3/4"	8	0.177	4.5	2.36	60	0.079	±2	0.079	±2	0.06	±1.6
14"	13.78	350	16.26	413	21.00	533.4	18.75	476.3	1"	12	0.256	5.6	8"	7.87	200	10.63	270	11.75	298.4	3/4"	8	0.177	4.5	2.36	60	0.079	±2	0.079	±2	0.06	±1.6
14"	13.78	350	16.26	413	21.00	533.4	18.75	476.3	1"	12	0.256	5.6	10"	9.84	250	12.76	324	14.25	362	7/8"	12	0.217	5.5	2.36	60	0.079	±2	0.079	±2	0.06	±1.6
14"	13.78	350	16.26	413	21.00	533.4	18.75	476.3	1"	12	0.256	5.6	12"	11.81	300	15.00	381	17.00	431.8	7/8"	12	0.217	5.5	2.36	60	0.079	±2	0.079	±2	0.06	±1.6







VADODARA



CORPORATE OFFICE

946, GIDC, Makarpura,
Vadodara - 390 010. INDIA
Phone : +91 - 265 - 2649248, 2632628
Fax : +91 - 265 - 2637379
Email : sales.baroda@polyvalve.com | mktg@polyvalve.com

FACTORY

5 to 12 PR Industrial Estate,
Por GIDC - Kashipura Road,
Moje : Kashipura - 391 243,
Dist. Vadodara. INDIA
Phone : +91 70434 30467/77 , 70430 20707

MUMBAI

THANE

207, Orion Business Park, Next to Cine Max, Kapurbawdi,
Ghodbunder Road, Thane (W) - 400 607. INDIA.
Phone : +91 - 22 - 25896422, 25896524 / 25
Fax : + 91 - 22 - 2589 - 4221
Email : sales.thane@polyvalve.com | mktg@polyvalve.com

USA



DJK - Energy Houston

BRANCH OFFICE

DJK-ENERGY HOUSTON INC.
13201, NW FWY, Suite 800,
Houston, Texas - 77040, USA
Phone : +1 832 213 9674
Email : djklinedvalvesamerica.us

www.polyvalve.com | www.polyvalve.in

AUTHORISED DISTRIBUTOR FOR
Australia/NZ/PNG/Philippines

RHINOFLEX™

RHINOFLEX VALVE SOLUTIONS PTY.LTD

4/7 Holder Way, Malaga, W.A 6090

Phone: +61 -08 61130808

sales@rfvs.com.au

- UNP Polyvalves reserves the right, without notice to alter improve the designs, specifications, dimensions of the products described herein.
- UNP Polyvalves does not assume any responsibility for the data given in this brochure. It is necessary for the customers to carry out necessary tests before selecting the MOC for their applications.